

# EURUS S6 INSTRUCTIONS FOR USE

## Dear Customers

Dear Customers

Thank you for purchasing our product.

This booklet explains how to use EURUS.

Before using EURUS, carefully read the operating instructions and make sure to use the product correctly.

Using the product without reading these instructions may lead to an accident.

For easy access to the information contained herein, keep this booklet at hand and review it as needed.

Ask your local authorized Belmont dealer to install this product by following the installation instructions contained in the product.

If you have any questions regarding the operating instructions or this product, contact your local authorized Belmont dealer.

If you find any dirt on or damage to the booklet and need a new booklet, report the catalog number indicated below to your local authorized Belmont dealer to order a new one.

This document describes the full version of the system. It may therefore cover components that are not included in the system you purchased.

2021-11 (3rd version)	
REF	1E089SCE

	Dear Customers .....	2
<b>1</b>	<b>General Information</b>	
1-1	Intended Use of the Product .....	8
1-2	Compliance with Directives .....	8
1-3	Declaration of Conformity .....	8
1-4	How to Dispose of the Device .....	9
1-5	Disposal of Residues .....	9
1-6	Compatible Handpieces .....	9
1-7	Compatible Dental Lights .....	9
1-8	Symbols .....	10
1-9	Technical Description .....	14
<b>2</b>	<b>Safety Consideration</b>	
2-1	Risk Level Interpretation .....	15
2-2	Safety Precautions .....	17
	Points to remember when operating the product .....	27
2-3	Locations Where Caution Labels Are Attached .....	29
2-4	EMC Information .....	32
2-5	Compatible Handpieces .....	36
2-6	Compatible Dental Lights .....	36
<b>3</b>	<b>Precautions for Use</b>	
3-1	Operating Precautions .....	37
3-2	Precautions for Using Synthetic Leathers .....	39
<b>4</b>	<b>Product Specifications</b>	
4-1	Technical Data .....	40
	4-1-1 Specification Variations .....	40
	4-1-2 S6 .....	41
4-2	System Overview .....	49
4-3	Name of Each Part .....	52
	4-3-1 Chair .....	52
	4-3-2 Headrest .....	53
	4-3-3 Foot Controller (wired/wireless) .....	53

## 4 Product Specifications

4-3-4	Doctor Unit .....	54
4-3-5	Cuspidor Unit .....	56
4-3-6	Vac Pac Unit .....	58
4-3-7	Assistant Unit .....	58
4-3-8	Junction Box .....	59

## 5 Operation

5-1	Preparation Before Use .....	60
5-2	After use .....	64
5-3	Operating the main switch for chair during treatment (when the main switch for chair is available) .....	65
5-4	Raising/lowering the chair and raising/reclining the backrest(manual operation) .....	66
5-5	Moving the chair to the preset position(automatic operation) .....	67
5-6	Operating the headrest (manual type) .....	68
5-7	Operating the headrest (electrohydraulic type) .....	69
5-8	Turning the armrest .....	70
5-9	Relationship among the angles of the backrest, legrest and footrest .....	71
5-10	Operating the legrest .....	72
5-11	Operating the doctor table .....	73
5-12	Control of the assistant tray .....	74
5-13	Handpiece .....	76
5-14	Doctor operation panel .....	77
5-15	Assistant operation panel .....	98
5-16	Cancellation function .....	102
5-17	Lock function .....	103
	5-17-1 Chair lock function .....	103
	5-17-2 Handpiece lock function .....	107
5-18	Micromotor .....	108
	Setting the micromotor slide mode (NBX/NLX plus/NLX nano/MX2/MCX) ...	108
	Setting the maximum rotation (NBX/NLX plus/NLX nano/MX2/MCX) .....	109
	Memory setting for starting condition after powering on(NBX/NLX plus/NLX nano/MX2/MCX) ...	110
	Gear conversion display function (NBX/NLX plus/NLX nano/MX2/MCX) ...	111
	Overheating prevention function (NBX/NLX plus/MX2/MCX) .....	112
	NLX plus .....	113
	MX2 .....	115

## 5 Operation

5-19	Ultrasonic scaler .....	122
	Perio/Endo/Scaling switch setting .....	122
	Setting of the maximum output in the slide mode Va .....	123
	Setting of the maximum output in the slide mode Fix .....	123
	Memory setting for starting condition after powering on .....	124
5-20	Air turbine/motor .....	125
	Setting of the slide mode .....	125
	Setting of the maximum output .....	126
	Memory setting for starting condition after powering on .....	127
5-21	Syringes .....	128
5-22	Foot controller (wired/wireless) .....	129
	5-22-1 Confirmation of the pairing of the wireless foot controller .....	130
	5-22-2 How to replace batteries of the wireless foot controller .....	131
	5-22-3 Cable connection of a wireless foot controller .....	132
	5-22-4 Operating precautions for the wireless foot controller .....	133
5-23	Maintenance panel .....	134
5-24	Handpiece (assistant holder) .....	135
5-25	Assistant hose clamp .....	135
5-26	Filling a Cup .....	136
5-27	LED indicator .....	137
5-28	Water bottle .....	138
5-29	USB port .....	139
5-30	EURUS Light .....	140
5-31	900 Dental Light .....	141
5-32	Monitor bracket .....	142
5-33	Panoramic viewer .....	142
5-34	Dental viewer .....	142

## 6 Setting/Adjustment

6-1	Setting for automatic operation .....	143
	6-1-1 Setting the treatment and entry/exit positions .....	143
	6-1-2 Setting the mouth rinsing position .....	143
	6-1-3 Freely setting the legrest angle .....	144
6-2	Function switch .....	145
	6-2-1 Setting items with the function switch .....	146
	6-2-2 Selecting the flushing method and carrying out flushing .....	147

## 6 Setting/Adjustment

6-2-3	Selecting the vacuum line washing method and conducting washing ...	156
6-2-4	Displaying the drive air pressure .....	173
6-2-5	Setting the spray mode .....	174
6-2-6	Setting the light activation timing .....	175
6-2-7	Setting the micromotor brightness .....	176
6-2-8	Setting the cupfiller water level .....	178
6-2-9	Setting the cup-filling/bowl flush interlock .....	180
6-2-10	Setting the bowl flush time .....	181
6-2-11	Setting the language .....	182
6-2-12	Setting the timer alarm tone .....	183
6-2-13	Setting the key touch volume .....	184
6-2-14	Setting the sleep mode time .....	185
6-2-15	Setting emergency cancellation of the chair lock .....	186
6-3	Adjusting the quantity of water/air supplied from the doctor unit .....	187
6-4	Adjusting the quantity of water/air supplied to the cuspidor unit .....	188

## 7 Maintenance and Cleaning

7-1	Exterior .....	189
7-1-1	Cleaning and disinfecting the surfaces .....	189
7-2	Chair .....	190
7-2-1	Leather part .....	190
7-3	Doctor unit .....	191
7-3-1	Touch panel .....	191
7-3-2	Silicone mat .....	191
7-3-3	Handle cover .....	192
7-3-4	Waste container holder .....	193
7-3-5	Instrument holder .....	193
7-3-6	Cleaning of 77-type 3WAY syringe .....	194
7-3-7	Handpiece hose .....	198
7-3-8	Oil mist separator .....	198
7-4	Cuspidor unit .....	199
7-4-1	Assistant holder .....	199
7-4-2	Assistant hose clamp .....	201
7-4-3	Assistant silicone mat .....	201
7-4-4	Washing and sterilizing the vacuum handpiece and saliva ejector handpiece .....	202

## 7 Maintenance and Cleaning

7-4-5	Vacuum line / Saliva ejector line .....	205
7-4-6	Cleaning of 77-type 3WAY syringe .....	205
7-4-7	Sensor window for cupfiller .....	205
7-4-8	Cuspidor bowl .....	206
7-4-9	Solid collector .....	208
7-4-10	Spittoon valve .....	209
7-4-11	Air filter .....	210
7-4-12	Air compressor .....	210
7-4-13	Vacuum pump .....	210
7-5	How to detach battery of the doctor unit .....	211
7-6	Maintenance and inspection .....	212
	Notes on daily maintenance and inspection (by the user) .....	212
	Notes for periodic inspection .....	214
7-7	Detachable parts .....	215
7-8	Storage method .....	215

## 8 Maintenance by Service Engineers

8-1	After-sales service .....	216
8-2	Service life .....	216
8-3	Period of Parts Retention .....	216

## 9 Troubleshooting

9-1	Troubleshooting .....	217
9-2	Message on the touch panel and measures to be taken .....	218

## 10 Accessories and Consumables

10-1	Accessories .....	221
10-2	Consumables .....	221

## 1-1 Intended Use of the Product

This product is an active therapeutic device intended for the exclusive use for diagnoses, treatments and relative procedures of dentistry. The product must be operated or handled by the qualified dentists or by dental staffs under the supervision of the dentist. Such dentists or dental staffs should instruct and/or assist the patients to approach to and leave from the product. Patients should not be allowed to operate or handle the product unless he/she is so instructed. The product is supplied together with the handpieces like electric micromotor, air turbine and/or motor, scaler and so on.

## 1-2 Compliance with Directives

This product complies with Medical Device Directive 93/42/EEC, RoHS Directive 2011/65/EU, and RE Directive 2014/53/EU.

## 1-3 Declaration of Conformity

We hereby declare that the product listed below complies with the essential requirements of the Medical Device Directive: 93/42/EEC and RoHS Directive: 2011/65/EU based on category 8 of Annex I.

Product : DENTAL UNIT AND CHAIR (CLASS II a)  
Model : EURUS S6

" EURUS " has been defined by the rule 9 of MDD Annex IX. The product has been designed and manufactured in accordance with the European standards as the listed in the Declaration of Conformity.

Our full quality assurance system has been approved to MDD ANNEX II, excluding section 4 (Registration No. HD 60143723 0001) by Notified Body, TUV Rheinland LGA Products GmbH (NO.0197).



## 1-4 How to Dispose of the Device

When disposing of this product and parts replaced, carefully take infection control measures and handle them properly in accordance with the relevant laws and regulations (applicable regulations and local regulations).

In the EU area, EU Directive 2012/19/EU (Directive on Waste Electrical and Electronic Equipment [WEEE Directive]) applies to this product. Environment-conscious recycling/disposal is mandatory under this Directive.

Remove all batteries when disposing of the product.

Batteries are located inside the wireless foot controller and doctor unit.

[Reference] How to detach battery of the doctor unit [Page 211]

[Reference] How to replace batteries of the wireless foot controller  
[Page 131]

## 1-5 Disposal of Residues

Ask a professional to dispose of amalgam residues.

## 1-6 Compatible Handpieces

Select a handpiece from the list of compatible handpieces.  
(For reference, see page 36.)

The connectors of our handpiece hose are designed and manufactured in accordance with ISO9168:2009 (DENTISTRY-HOSE CONNECTORS FOR AIR DRIVEN DENTAL HANDPIECES). However, there still could be a case that the connectors of turbines or air motors may not fit into some handpieces due to the manufacturing tolerances. Have your local authorized Belmont dealer to check the connectability before purchasing the handpiece.





























Except for our recommended handpieces, we shall not be liable for any problems deriving from bad connectability or their performance.

## 1-7 Compatible Dental Lights



























Select a dental light from the list of compatible dental lights.  
(For reference, see page 36.)

## 1-8 Symbols

The symbols listed below are used on this product, on labeling, and in this booklet. Check the meaning of each symbol.

	Switch (ON)		Switch (OFF)
	Switch for raising the chair/headrest		Switch for lowering the chair/headrest
	Switch for reclining the backrest/headrest		Switch for raising the backrest/headrest
	Switch for changing to the chair/headrest		Switch for returning to the last position
	Automatic return switch		Preset switch 1
	Preset switch 2		Dental light switch ON/OFF
	Cup filler switch/flow control		Bowl flush switch/flow control
	Extra switch		Stick switch for headrest (electrohydraulic)
	Stick switch for manual operation		Stick switch for automatic operation
	Service coupler for water use		Water flow control of service coupler for water use
	Service coupler for air use		Water/air flow control of syringe spray
	Water flow control of handpiece spray		Draining water from air filter
	Protective earthing		Functional earthing
	Caution *The base color is yellow.		General warning sign *The base color is yellow.



























# 1 General Information

	Generally prohibited activity		Disassembly, repair or modification prohibited
	Instructions for mandatory actions in general		Follow instructions for use *The color of black part is blue in the actual label.
	Type B Applied Parts contacting the patient's body surface only		Alternating current
	An autoclave symbol that indicates parts can be sterilized in an autoclave at temperatures up to 135°C		USB terminal
	Year of manufacture	<b>S N</b>	Serial number
	Switch for selecting the patient's memory (Adult Mode)		Switch for selecting the patient's memory (Child Mode)
	Switch for selecting the patient's memory (Elderly Mode)		Switch the user memory
	Dental light switch ON		Dental light switch OFF
	Timer switch		Cupfiller switch ON
	Cupfiller switch OFF		Bowl flush switch ON
	Bowl flush switch OFF		Function switch
	Light change switch		Sensor/switch mode
	Switch mode		ON mode
	OFF mode		Lock switch (unlocked)







# 1 General Information

	Lock switch (locked)		Water heater switch ON
	Water heater switch OFF		Handpiece No. picked up
	Handpiece heater switch High		Handpiece heater switch Low
	Handpiece heater switch OFF		Wireless foot controller indicator (paired)
	Wireless foot controller indicator (not paired)		Flushing status for handpiece (flushing in progress)
	Page feed		Flushing status for cupfiller and bowl (flushing in progress)
	Start		Pause
	Cancel		Spray change switch, Air ON
	Spray change switch, Air OFF		Spray change switch, Water ON
	Spray change switch, Water OFF		Handpiece light switch (ON)
	Handpiece light switch (OFF)		Bell switch
	Select switch (e.g. brightness of handpiece)		Show the menu
	Micromotor rotation switch for normal rotation (clockwise)		Micromotor rotation switch for reverse rotation (counterclockwise)
	Reciprocal mode switch for micromotor		Micromotor rotation switch for reciprocal mode

# 1 General Information

	+/- switch		Store switch
	Torque control switch		Slide mode change switch Slide mode Va
	Slide mode change switch Slide mode Fix		No automatic reverse setting
	Automatic reverse setting		Automatic forward setting
	Gear ratio change switch		Home switch
	Return switch		Skip switch
	Name registration switch		Alphanumeric switch
	Backspace switch		Chair preset copy
	Handpiece setting copy		Alarm volume
	Touch bar graph		Alarm sound switch (active)
	Alarm sound switch (muted)		Alarm sound type
	Overheat prevention activate		Chair lock indicator (chair is locked!)
	Explanation page		Flushing, Washing the vacuum line
	Vacuum/saliva ejector		Indication of cleaner

# 1 General Information

	Separate collection of electrical and electronic equipment	<b>for battery</b> 	Separate collection of all batteries
	Catalog number		European Authorized Representative
	Third-party certification stipulated in Medical Device Directive 93/42/EEC		Name and address of the manufacturer

## 1-9 Technical Description

The following are explained in the documents listed below:

Item	Document
How to install this product	Installation instructions Pre-installation instructions
Wiring/plumbing	Installation instructions

### 2-1 Risk Level Interpretation

#### Precautions before use

Make sure to carefully read the Safety Precautions and Operating Precautions and use the product correctly.

These precautions are intended to ensure the safe use of the product and prevent harm or damage to users or other people.

According to the magnitude of harm and damage and the degree of urgency, an incident that may be caused by misuse of the product is classified into one of the following categories: CONTRAINDICATION, WARNING, and CAUTION.

All of these categories are important for safety. Always follow the instructions provided.

We assume no responsibility for any accident due to failure to follow the Safety Precautions or Operating Precautions even in the event of harm or damage to users or other persons.

In such case, users or other persons who use the product without observing the Safety Precautions and Operating Precautions are responsible for any harm or damage incurred.

The graphical symbols are explained in detail below.

Once you have fully understood this explanation, read the text.

## 2 Safety Consideration

Classification by degree of harm or damage and urgency

### CONTRAINDICATION

Use of the product without regard to this indication will create a hazardous condition that may result in death or serious injury.

### WARNING

Improper handling of the product without regard to this indication will create a hazardous condition that may result in death or serious injury.

### CAUTION

Improper handling of the product without regard to this indication will create a potentially hazardous condition that may result in moderate or slight injury or property damage.

The following graphical symbols are used to explain your responsibilities for using the product safely:

#### Graphical symbols for prohibited activity



Generally prohibited activity



Disassembly, repair or modification prohibited

#### Graphical symbol for mandatory instructions



Instructions for mandatory actions in general



### 2-2 Safety Precautions

## CONTRAINDICATION

Installing or transferring the product



#### Precautions regarding installation

Do not install the product near electromagnetic sources such as communication facilities or elevators.

Malfunction of this product may occur in the presence of electromagnetic interference waves.

Use and maintenance of the product



**Do not use the equipment in an explosive atmosphere (e.g., in the presence of inflammable gases).**

Improper use in such an atmosphere may cause injury or fire.

**Use with caution in the presence of electromagnetic waves.**

Do not use equipment generating electromagnetic waves, such as mobile phones, around this product.

Malfunction of this product may occur.

**Be sure to turn off the main switch of the product when HF surgical equipment is in use.**

Be sure to turn off the main switch when HF surgical equipment is in use because the noise generated from HF surgical equipment may cause incorrect operation of this product.



**Never disassemble, repair or modify the product.**

Individuals other than your local authorized Belmont dealer should not disassemble or repair this product.

This could lead to an accident, failure, electric shock, or fire.

Never modify the product as it is extremely dangerous.

### **WARNING**

#### Installing or transferring the product



#### Precautions for installation

Ask your local authorized Belmont dealer to install the product.

Make sure to place the product on a firm and flat floor. Placing the equipment on a non-flat floor may cause it to fall.

Be sure to ground the product securely. (Ask a professional to ground the product.)

Failure or electric leak may result in electric shock.

To avoid the risk of electric shock, this equipment must only be connected to a supply mains with protective earth.

#### Use and maintenance of the product



**Keep moving parts of the product away from patients' and users' hands, fingers, and bodies.**

Hands, fingers or bodies may become caught in the product, causing injury.

**The patient must not lie on his/her stomach, kneel in the formal seiza position (with his/her buttocks on his/her heels), or sit on the product with a child in his/her arms.**

The chair may move unexpectedly, causing injury.

**The patient must not sit on the edge of the seat.**

The chair may fall or move unexpectedly, causing injury or damage to peripheral devices.

**The patient must not sit in an area other than the designated location.**

Excessive load must not be applied to the product.

The patient must not sit on the headrest, armrest, backrest, or legrest.

This may cause injury due to falling, or damage to peripheral devices.

**Excessive load must not be applied to the doctor arm or assistant arm.**

The patient must not sit on the doctor arm or assistant arm.

This may cause injury due to falling, or damage to peripheral devices.

**A load exceeding the weight limit (3 kg) must not be applied to the doctor table.**

This may cause damage or injury.

**A load exceeding the weight limit (1.5 kg) must not be applied to the assistant tray.**

This may cause damage or injury.

### WARNING

Use and maintenance of the product



The patient should clasp his/her hands.



The patient should place his/her feet side by side.

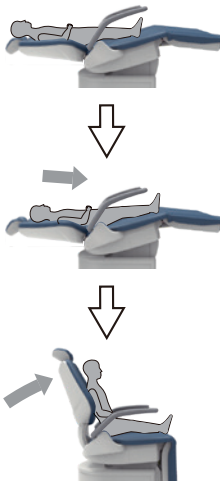

Do not wash the product with water.  
This may cause failure or electric shock.

**Points to remember when a patient sits on the chair**  
As shown in the figure on the left, instruct the patient to sit on the chair and make sure his/her body fits into the chair.  
Ensure that the patient maintains a good posture before moving the chair.

For a young child, confirm that the buttocks are placed on the seat before raising the backrest.  
The child might slide down while the chair is moving, resulting in injury.

### **Pay attention to patients and children.**

Keep your eyes on the patient when this product is in use.  
Patients (especially children) may touch the control switch or system inadvertently, leading to an accident due to incorrect operation of the product.

Keep children away from this product except when giving treatment.

### Use and maintenance of the product



## WARNING

### **Precautions for getting on and off EURUS**

When the patient gets on or off EURUS, the chair should always be at the lowest position and each operation must be locked by the lock switch.

Before moving a patient from a wheelchair to EURUS or vice versa, ensure that no obstacles (e.g., foot controllers) are situated around the wheelchair or the caregiver.

Contact of the feet or the wheelchair castors with obstacles (such as foot controllers) may cause injury or damage to peripheral devices.

When the patient is moved from a wheelchair to EURUS or vice versa, he/she must be carefully monitored to prevent falling.

If the patient has to get off EURUS at a position other than the designated position for getting on and off EURUS due to power failure or in the event of an emergency, he/she must be carefully monitored to prevent falling.

### **Remove the patient's glasses and any accessories (such as a necklace or bracelets) before treatment.**

Failure to follow this instruction may hamper treatment and lead to an accident.

### **Precautions when raising/lowering the backrest**

Before lowering the backrest, ensure that the patient's arm or hand is not sandwiched between the backrest and the seat.

Before raising the backrest, ensure that the patient's arm or hand is not sandwiched between the backrest and the armrest.

If the backrest is lowered during automatic operation, the legrest will be raised. Operate the backrest carefully to prevent the patient's toes from contacting the peripheral devices.

If the backrest is raised during automatic operation, the legrest will be lowered. Operate the backrest carefully after ensuring that the space beneath the legrest is clear of people and objects.

### **Precautions for operating the chair and automatic operation**

Before and during the chair operation, pay close attention to the operation range (seat raising/lowering direction, backrest lowering/raising direction, and legrest traveling direction), and ensure that the chair does not contact any body parts, hands or feet, or obstacles. Body parts, hands or feet, or objects may become caught in the chair, causing injury or damage to peripheral devices.

Before operating the chair, ensure that the patient is sitting in the correct position, and keep your eyes on him/her when the chair is in use.

### Use and maintenance of the product



## WARNING

### **Precautions when using the headrest (electrohydraulic)**

Before operating the headrest, ensure that the patient is sitting in a normal position and keep your eyes on him/her when the chair is in use.

[Reference] Points to remember when a patient sits on the chair [page 19]

Do not use the headrest at an angle at which the patient feels pain.

Before operating the headrest, ensure that no obstacles are placed around the headrest and make sure that there are no body parts or objects sandwiched between the headrest and the backrest.

### **Precautions when using the headrest (manual)**

During the headrest operation, ensure that your fingers do not become caught in the control lever and are not sandwiched between the headrest and the backrest.

### **Pay attention to inadvertent use of wireless foot controllers.**

If there is more than one EURUS on the same floor, do not operate a wireless foot controller connected to another product.

### **Precautions when using a micromotor (NBX, NLXplus, NLX-nano) with an anti-heat function**

When the anti-heat function is activated, do not turn on the main switch for the power cycle and continue operation. The micromotor may generate heat and cause the burns or motor's damages.

### **Development of subcutaneous emphysema**

Cooling air (alone or spray) is released from the chip of the handpiece (micromotor and air turbine/motor). This may cause the patient to develop subcutaneous emphysema, so use cooling air with caution.

### **Pay close attention to a patient who has a cardiac pacemaker or defibrillator implanted.**

If any abnormality occurs, immediately turn off the main switch and discontinue use of the product.

EURUS may affect the function of the pacemaker or defibrillator, leading to an accident.

### Use and maintenance of the product



## WARNING

### **Prohibition of using this equipment adjacent to or stacked with other electronic equipment**

Use of this equipment adjacent to or stacked with other equipment should be avoided because it could result in improper operation. If such use is necessary, this equipment and the other equipment should be observed to verify that they are operating normally.

### **Prohibition of placing portable RF communications equipment adjacent to this product**

Portable RF communications equipment (including peripherals such as antenna cables and external antennas) should be used no closer than 30 cm (12 inches) to any part of EURUS, including cables specified by the manufacturer. Otherwise, degradation of the performance of this equipment could result.

### **Immediately wipe off any water spillage or leakage on the floor.**

Decreased strength of the floor may cause the product to fall, leading to injury or damage to peripheral devices.

### **Clean the product thoroughly.**

Poor cleaning may cause bacteria to grow, posing a health risk. See cleaning procedures on pages 189 to 210.

### **Be sure to conduct maintenance.**

Use of the product without maintenance may cause injury or damage to peripheral devices.

See maintenance information on pages 212 to 214.

### **Discontinue use of the product if it is broken.**

In the case of a broken product, immediately discontinue use and turn off the main switch. Then, ask your local authorized Belmont dealer to repair the product.

### **Turn off the main switch during cleaning.**

Failure to follow this instruction may cause electric shock or ignition. The product may also move unexpectedly, causing injury.

### **Action taken for power failure**

To prevent unexpected operation of the product after recovery from power failure, turn off the main switch and put the handpiece/syringe in the instrument holder/assistant holder.

### **Be sure to turn off the breaker for devices when the product is not used for a long period of time.**

Make sure to turn off the breaker for devices in a clinic when the product is not used for a long time for reasons such as closing time and non-consultation day.

If the breaker is not turned off, a fire may be caused by a leakage of electricity due to insulation deterioration.

Use and maintenance  
of the product



### CAUTION

**Do not allow a person who exceeds the weight limit to sit on the chair.**

Falling or operational failure may occur.

[Reference] Weight limit

4 Product Specifications, 4-1 Technical Data [Pages 43]

**Do not hit or rub the product.**

This may cause damage to the cover or operational failure.

**Use a battery specified by Belmont only for the wireless foot controller.**

Do not combine a new battery with an old one and do not use different types of batteries (e.g., an alkaline battery and a nickel-hydrogen battery). Improper use of batteries may lead to battery leakage or rupture.

**Do not touch leakage from a battery.**

Contact of battery fluids with the eyes may result in blindness.

Rinse with clean water immediately without rubbing, and consult a physician promptly.

Contact of battery fluids with the skin may cause skin disorders, so immediately rinse with clean water.



**Ensure that each part operates normally, with no abnormalities detected, before operation.**

Always inspect the product for abnormal findings such as loose components, backlash, tilting, vibration, sound, abnormal temperature, or bad odors.

If you feel something is wrong, immediately discontinue use of the product and turn off the main switch. Then, contact your local authorized Belmont dealer.

**Read the accompanying documents for each device.**

Before use, make sure to carefully read the instructions for use supplied with each device and use the device correctly.

**Be sure to operate switches manually.**

Make sure to operate the switches manually, except for the foot controller operated by the foot and stick switches. Failure to operate the switches by hand may cause damage or malfunction.

**Carefully operate the switches to prevent a mistake.**

The operator should pay close attention to people around the product and say something before operation to prevent any errors.

### Use and maintenance of the product



## CAUTION

**Peel off the film attached to the touch panel before initial use**  
Using the touch panel with the film attached may lead to incorrect operation, resulting in injury.

### **Precaution when cleaning the touch panel**

To clean and disinfect the touch panel, use ethanol for disinfection. Using other disinfectant may lead to incorrect operation, resulting in injury.

Be certain to wipe off all water and detergent. Otherwise, it may cause operational failure, malfunction, resulting in injury.

### **Precautions for moving the doctor unit**

Carefully look around while moving the doctor unit. Contact with the chip of the handpiece may cause injury.

### **Precautions when using the cart**

When using the cart within the operation range of the chair, pay attention not to collide with person or chair. Contact with the tip of the handpiece may cause injury.

Do not sit or lean on the cart. Do not step on the cart base or cart hose. Otherwise, such actions may damage the hose or cause the cart to fall resulting in injury.

### **Precautions when using a handpiece**

In the event of heat or smoky smell, stop using the handpiece, turn off the main switch, and contact your local authorized Belmont dealer.

This may cause burns or have an adverse effect on the dental pulp.

### **Precautions when using an ultrasonic scaler**

After use, attach a dedicated cover (if any) to the scaler tip and put it in an instrument holder. Contact with the tip of the scaler may cause injury.

### **Precautions when using a dedicated function for NLXplus/MX2**

If a reverse-screw-shaped file is attached, make sure to select "No auto reverse function," and change the rotation direction by micromotor rotation switch. If the NLXplus/MX2 is used with "Auto reverse function/Auto forward function" selected, the file will be damaged, causing injury.



### Use and maintenance of the product



## CAUTION

### Precautions for armrest rotation

Ensure that no obstacles are placed around the armrest and fingers do not become caught in the armrest.

Do not operate the chair when the armrest is rotated. Before operating the chair, return the armrest to its original position.

### Precautions when using a monitor bracket

Do not apply excessive load to or make an impact on a monitor or monitor bracket. Do not mount a monitor if it does not meet the conditions provided below to prevent damage or injury.

Size, 21 inches; weight, 6 kg

### Precautions when handling batteries

Remove the battery from the wireless foot controller when it is not used for more than a week.

Turn off the main switch during battery replacement. If not, and a switch or pedal may be pressed mistakenly, it will lead to incorrect operation of the product and may cause any damage to the person or property.

Put on the cleaning gloves when detaching cuspidor bowl. Cuspidor bowl is made of ceramic that might cause injury when broken.

Immediately wipe off any drug solutions or water adhered to EURUS.

Adherence of drug solutions or water to the control unit may cause operational failure or electrical leak. If drug solutions or water are adhered, immediately turn off the main switch and wipe them off with a dry, soft cloth.

**Close the main water valve at the end of day.**

To prevent the water leakage, make sure to close the main water valve at the end of day.

**Turn off the main switch at the end of day or during a recess.**

Malfunction due to contact with EURUS will cause damage or injury.

### CAUTION

Safety precautions regarding water quality



#### Conduct flushing before treatment.

If this product is not used for a long time, water retained in ducts and in the water heater will be susceptible to bacterial growth. To provide safe treatment and operate the handpiece without any trouble, never forget to perform flushing (discharge) of the water lines before starting treatment.

To inhibit the growth of various bacteria, you are recommended to carry out flushing with fresh water at the end of treatment in the morning and evening.

Time required for standard flushing of the unit water lines

Flushing water circuits of handpieces	40 seconds
Air turbine	
Micromotor	
Air motor	
Ultrasonic scaler	
Syringe	

Flushing the water circuits of handpieces	
Flushing the water circuits of cupfiller and cuspidor bowl	10 minutes
Air turbine	
Micromotor	5 minutes
Air motor	
Ultrasonic scaler	
Syringe	
+	
Cupfiller	
Bowl flush	5 minutes

Time required for standard washing for the vacuum line

Rinsing the vacuum line	4 minutes
Washing the vacuum line with cleaner	4 minutes
Rinsing the vacuum line+washing the vacuum line with cleaner	8 minutes

If the cuspidor bowl is not equipped, the functions to flush the water circuits of cupfiller and cuspidor bowl (5 minutes) are not available.

[Reference] Selection and implementation of flushing method  
[pages 147 to 155]

## 2 Safety Consideration

### Points to remember when operating the product

#### Meaning of a symbol



Point to remember  
(locations requiring attention including moving parts, rotating parts, and detachable parts)



Point to remember where an emergency stop mechanism is available

#### Meanings of each point to remember

- ① Pay attention to prevent contact with the cuspidor bowl.  
When the cuspidor bowl is rotated to the side of the chair, keep it away from the armrest and the patient.
- ② Pay attention to prevent contact with the assistant holder.  
The upper part of the patient's body should not lean forward over the cuspidor unit.
- ③ Pay attention to prevent body parts or objects from becoming caught in the bottom of the legrest.  
Ensure that feet are not placed beneath the legrest.
- ④ Pay attention to prevent body parts or object from becoming caught in the armrest.  
Do not operate the chair when the armrest is rotated.
- ⑤ Pay attention to prevent body parts or objects from becoming caught in the backrest moving parts.  
Ensure that hands or feet are not sandwiched between the backrest and the seat.
- ⑥ Pay attention to prevent body parts or objects from becoming caught in the bottom of the seat.  
Ensure that hands or feet are not placed in the bottom of the seat.
- ⑦ Pay attention to prevent body parts or objects from becoming sandwiched between the cuspidor and the chair.  
Before operating the chair, ensure that no obstacles are placed between the cuspidor and the chair.
- ⑧ Pay attention to prevent body parts or objects from becoming caught in the headrest moving parts.  
Ensure that fingers or hair do not become caught in the headrest moving parts.
- ⑨ Pay attention to prevent contact of the chair with the doctor unit.  
Do not place the doctor unit within the operational range of the chair.
- ⑩ Pay attention to prevent contact with the light.  
The light should not be placed near people or surrounding obstacles.
- ⑪ Pay attention to prevent contact of the chair with the cart.  
Do not place the cart within the operation range of the chair.
- ⑫ Pay attention to prevent objects from interfering with the cuspidor bottom and junction box.  
Ensure that the junction box lid is closed, and that there are no interfering objects when operating the chair.

Base mount

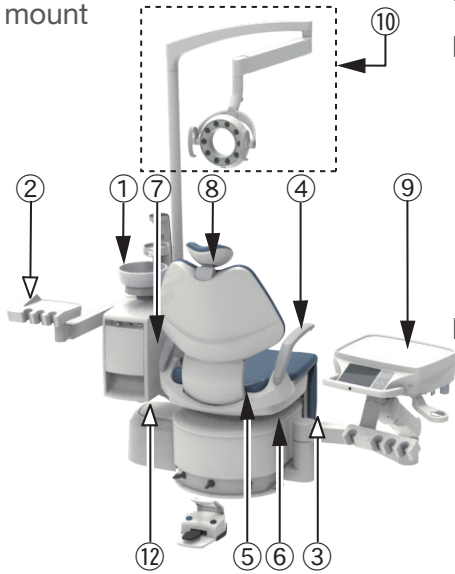

Cart

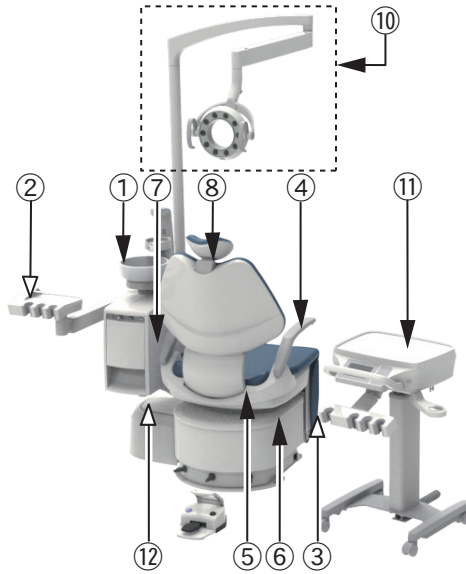

Cabinet delivery

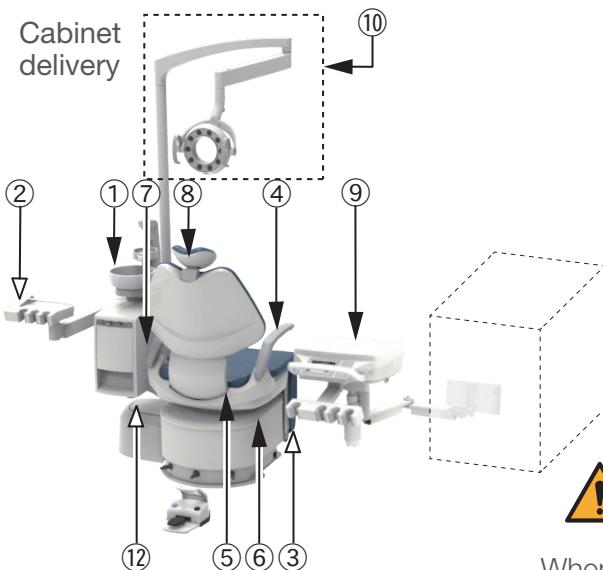

## WARNING

When operating the chair, do not place the body parts or objects around the moving parts. This may cause injury.

## 2 Safety Consideration

### Points to remember when operating the product

#### Meaning of a symbol



Point to remember  
(locations requiring attention including moving parts, rotating parts, and detachable parts)



Point to remember where an emergency stop mechanism is available

#### Meanings of each point to remember

- ① Pay attention to prevent contact with the assistant holder. The upper part of the patient's body should not lean forward over the cuspidor unit.
- ② Pay attention to prevent body parts or objects from becoming caught in the bottom of the legrest. Ensure that feet are not placed beneath the legrest.
- ③ Pay attention to prevent body parts or object from becoming caught in the armrest. Do not operate the chair when the armrest is rotated.
- ④ Pay attention to prevent body parts or objects from becoming caught in the backrest moving parts. Ensure that hands or feet are not sandwiched between the backrest and the seat.
- ⑤ Pay attention to prevent body parts or objects from becoming caught in the bottom of the seat. Ensure that hands or feet are not placed in the bottom of the seat.
- ⑥ Pay attention to prevent body parts or objects from becoming sandwiched between the Vac Pac and the chair. Before operating the chair, ensure that no obstacles are placed between the cuspidor and the chair.
- ⑦ Pay attention to prevent body parts or objects from becoming caught in the headrest moving parts. Ensure that fingers or hair do not become caught in the headrest moving parts.
- ⑧ Pay attention to prevent contact of the chair with the doctor unit. Do not place the doctor unit within the operational range of the chair.
- ⑨ Pay attention to prevent contact with the light. The light should not be placed near people or surrounding obstacles.
- ⑩ Pay attention to prevent contact of the chair with the cart. Do not place the cart within the operation range of the chair.
- ⑪ Pay attention to prevent objects from interfering with the Vac Pac bottom and junction box. Ensure that the junction box lid is closed, and that there are no interfering objects when operating the chair.

Base mount  
Vac Pac

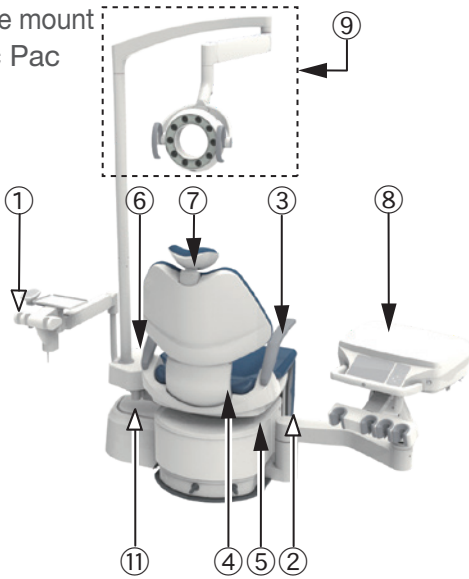

Cart  
Vac Pac

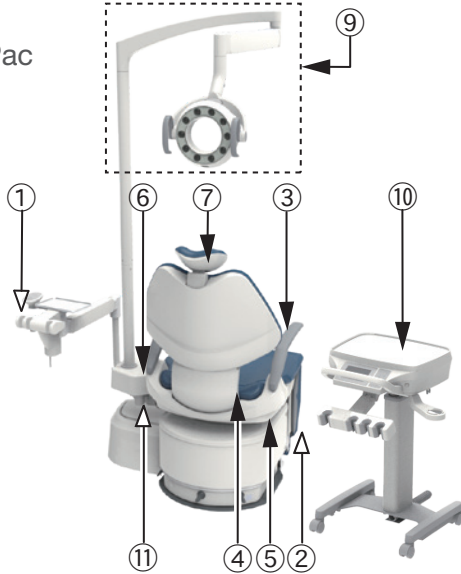

Cabinet delivery  
Vac Pac

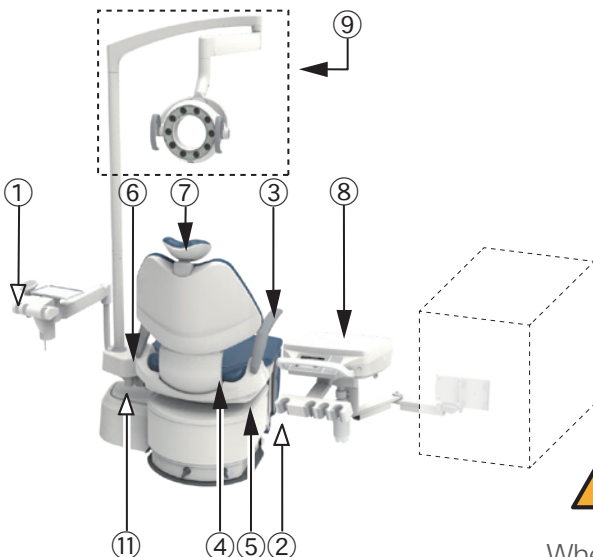

## WARNING

When operating the chair, do not place the body parts or objects around the moving parts. This may cause injury.

## 2 Safety Consideration

### 2-3 Locations Where Caution Labels Are Attached

Base mount

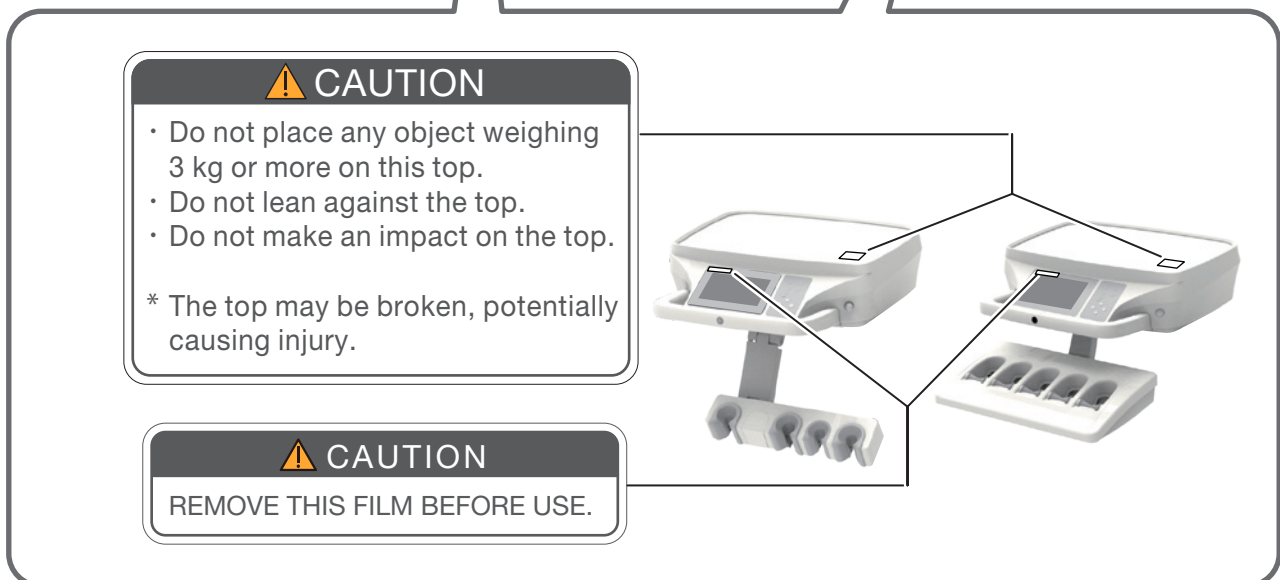
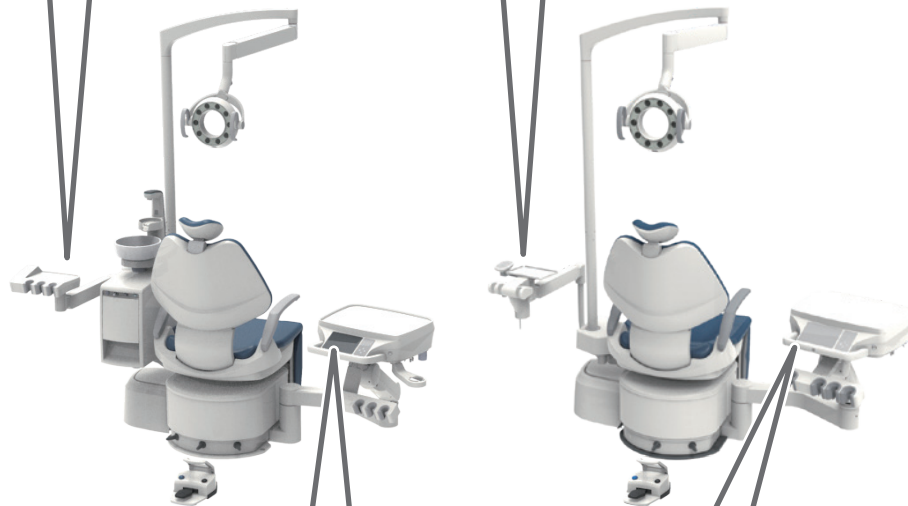

## 2 Safety Consideration

### Cart

**⚠ CAUTION**

- Do not push or pull this arm hard. Otherwise the arm may get damaged.

**⚠ CAUTION**

- Do not place any object weighing 1.5 kg or more on this top.
- Do not lean against the top.
- Do not make an impact on the top.

\* The top may be broken, potentially causing injury.

**⚠ CAUTION**

- Do not place any object weighing 3 kg or more on this top.
- Do not lean against the top.
- Do not make an impact on the top.

\* The top may be broken, potentially causing injury.

**⚠ CAUTION**

WHEN USING THE CART,

- PAY ATTENTION NOT TO COLLIDE WITH PERIPHERAL EQUIPMENT OR PERSON.
- ※THE LEATHER OF THE CHAIR MAY RIP AT THE TIP OF THE HANDPIECE.
- ※THE PRODUCT MAY BE DAMAGED.
- DON'T MOVE IT VIGOROUSLY.
- HOLD THE HANDLE TO MOVE.
- DON'T LIFT THE CART WITH THE HANDLE.
- DON'T PLACE ANY OBJECT WEIGHING 3 kg OR MORE.
- DON'T SIT ON THE CART OR STEP ON THE CART BASE.
- DON'T LEAN ON IT.
- DON'T STEP ON THE CART HOSE.
- ※THE PRODUCT MAY BE DAMAGED.
- ※THERE IS A RISK THAT OBJECTS ON THE TOP WILL CRASH TO THE FLOOR.
- ※FALL AND INJURY MAY OCCUR.
- WHEN THE PATIENT GETS ON AND OFF THE CHAIR, KEEP THE CART AWAY FROM THE PATIENT.
- ※THE PATIENT MAY TRIP ON THE HOSE, RESULTING IN INJURY.

**⚠ CAUTION**

REMOVE THIS FILM BEFORE USE.

## 2 Safety Consideration

### Cabinet delivery

**⚠ CAUTION**

- Do not push or pull this arm hard. Otherwise the arm may get damaged.

**⚠ CAUTION**

- Do not place any object weighing 1.5 kg or more on this top.
- Do not lean against the top.
- Do not make an impact on the top.

\* The top may be broken, potentially causing injury.

**⚠ CAUTION**

- Do not place any object weighing 3 kg or more on this top.
- Do not lean against the top.
- Do not make an impact on the top.

\* The top may be broken, potentially causing injury.

**⚠ CAUTION**

REMOVE THIS FILM BEFORE USE.

### 2-4 EMC Information

This product complies with EMC Standard EN60601-1-2:2015.

#### 1. Precautions regarding EMC and compliance with accompanying documents

Medical electrical equipment requires special precautions regarding EMC and needs to be installed and put into service according to the EMC information provided in this booklet.

#### 2. Effects of RF communication devices

Portable and mobile RF communication devices can affect medical electrical equipment.

#### 3. Installation exclusion environment

Hospitals except for near active HF SURGICAL EQUIPMENT and the RF shielded room of an ME SYSTEM for magnetic resonance imaging, where the intensity of EM DISTURBANCES is high.

#### 4. Electromagnetic emission declaration

Guidance and manufacturer's declaration—electromagnetic emissions			
EURUS is intended for use in the electromagnetic environment specified below. The customer or user of EURUS should ensure that it is used in such an environment.			
Emissions test	Compliance		Electromagnetic environment—guidance
	Japan	CE	
RF emissions CISPR 11	Group 1		EURUS only uses RF energy for its internal functions. Therefore, its RF emissions are very low and are not likely to cause any interference with nearby electronic equipment.
RF emissions CISPR 11	Class B		EURUS is suitable for use in all establishments, including domestic establishments and those directly connected to the public low-voltage power supply network that supplies buildings used for domestic purposes.
Harmonic emissions IEC 61000-3-2	Not applicable	Class A	
Voltage fluctuations/ Flicker emissions IEC 61000-3-3	Not applicable	Complies	



Use of this equipment adjacent to or stacked with other equipment should be avoided because it could result in improper operation. If such use is necessary, this equipment and the other equipment should be observed to verify that they are operating normally.



### 5. Electromagnetic immunity declaration 1

Guidance and manufacturer's declaration—electromagnetic immunity			
EURUS is intended for use in the electromagnetic environment specified below. The customer or user of EURUS should ensure that it is used in such an environment.			
Immunity test	IEC 60601 test level	Compliance level	Electromagnetic environment—guidance
Electrostatic discharge (ESD) IEC 61000-4-2	±8 kV contact ±15 kV air	±8 kV contact ±15 kV air	Flooring should be wood, concrete, or ceramic tiles. If the floor is covered with synthetic material, the relative humidity should be at least 30%.
Electrical fast transient/burst IEC 61000-4-4	±2 kV for power supply lines ±1 kV for input/output lines	±2 kV for power supply lines ±1 kV for input/output lines	The mains power quality should be that of a typical commercial or hospital environment.
Surge IEC 61000-4-5	±1kV differential mode ±2kV common mode	±1kV differential mode ±2kV common mode	The mains power quality should be that of a typical commercial or hospital environment.
Voltage dips, short interruptions and voltage variations on power supply input lines IEC 61000-4-11	0% UT ; 0.5 cycles  0°, 45°, 90°, 135°, 180°, 225°, 270° and 315°  0% UT ; 1 cycle and  70% UT ; 25/30 cycles at 0°, single phase  0% UT ; 250/300 cycles	0% UT ; 0.5 cycles  0°, 45°, 90°, 135°, 180°, 225°, 270° and 315°  0% UT ; 1 cycle and  70% UT ; 25/30 cycles at 0°, single phase  0% UT ; 250/300 cycles	The mains power quality should be that of a typical commercial or hospital environment. If the user of EURUS requires continued operation during mains power interruptions, it is recommended that EURUS be powered from an uninterruptible power supply or a battery.
Power frequency (50/60 Hz) magnetic field IEC 61000-4-8	30A/m	30A/m	Power frequency magnetic fields should be at levels characteristic of a typical location in a typical commercial or hospital environment.
Note UT is the AC mains voltage prior to the application of the test level.			

### 6. Electromagnetic immunity declaration 2

Guidance and manufacturer's declaration—electromagnetic immunity			
EURUS is intended for use in the electromagnetic environment specified below. The customer or user of EURUS should ensure that it is used in such an environment.			
Immunity test	IEC 60601 test level	Compliance level	Electromagnetic environment —guidance
Conducted RF IEC 61000-4-6	3V 0.15MHz-80MHz  6V 0.15MHz-80MHz in ISM bands and amateur radio bands	3V 0.15MHz-80MHz  6V 0.15MHz-80MHz in ISM bands and amateur radio bands	Warning: Portable RF communications equipment (including peripherals such as antenna cables and external antennas) should be used no closer than 30 cm (12 inches) to any part of EURUS, including cables specified by the manufacturer. Otherwise, degradation of the performance of this equipment could result.
Radiated RF IEC 61000-4-3	3V/m 80MHz-2.7GHz 80% AM (1 kHz)	3V/m 80MHz-2.7GHz 80% AM (1 kHz)	
Near electromagnetic field caused by RF wireless communication devices IEC61000-4-3	See the table on the next page (page 35)	See the table on the next page (page 35)	

### 7. Essential performance

Unless operated by the chair control switch, the chair will not make any movements. Unless operated by the foot controller, the handpiece will not move except for sounding a buzzer and switching the indicator on/off.

Loss or decline of essential performance may cause the chair or handpiece to move unexpectedly, causing harm or damage to the patient, operator or people or objects around the patient or operator.

## WARNING

Portable RF communications equipment (including peripherals such as antenna cables and external antennas) should be used no closer than 30 cm (12 inches) to any part of EURUS, including cables specified by the manufacturer. Otherwise, degradation of the performance of this equipment could result.

### Near electromagnetic field caused by RF wireless communication devices

Test frequency (MHz)	Modulation	IEC 60601 test level	IEC 60601 compliance level
385	Pulse modulation <sup>a)</sup> 18Hz	27V/m	27V/m
450	Frequency modulation ±5kHz shift 1kHz sine wave	28V/m	28V/m
710 745 780	Pulse modulation <sup>a)</sup> 217Hz	9V/m	9V/m
810 870 930	Pulse modulation <sup>a)</sup> 18Hz	28V/m	28V/m
1720 1845 1970	Pulse modulation <sup>a)</sup> 217Hz	28V/m	28V/m
2450	Pulse modulation <sup>a)</sup> 217Hz	28V/m	28V/m
5240 5500 5785	Pulse modulation <sup>a)</sup> 217Hz	9V/m	9V/m
Note a) The carrier is modulated by a square wave with a 50% duty cycle.			

### 2-5 Compatible Handpieces

The following handpieces are compatible with this product:

Syringe	BT14
	77-type 3WAY
	DCI
	LUZZANI 3WAY
	LUZZANI 6WAY
Air turbine	BIEN AIR BORA S36L/UNIFIX with LIGHT
	NSK Ti-Max X
	NSK MACH-LITE XT
	NSK PANA-MAX
Air motor	BIEN AIR Aquilon 830/UNIFIX with LIGHT /PM1132
	NSK EX-203/EX-6
Micromotor	BIEN AIR MX2 (DMX3)
	BIEN AIR MCX
	NSK NLX plus
	NSK NLX nano
	NSK NBX
Scaler	NSK VARIOS VS170 SCALER
	NSK VARIOS VS170 LUX SCALER
	DENTSPLY CAVITRON SCALER(TYPE G139)
	SATELEC SP4055 NEWTRON
	SATELEC Xinetic
	EMS NO PAIN
Curing light	SATELEC MINI LED STD OEM
Intraoral camera	SOPRO ACTEON SOPRO 617
	SOPRO ACTEON SOPRO CARE
	I.C.LERCHER L-CAM HD SHOT

### 2-6 Compatible Dental Lights

The following dental lights are compatible with this product:

Dental light	EURUS LIGHT
	900 DENTAL LIGHT

### 3-1 Operating Precautions

Immediately wipe off any drug solutions adhered to EURUS. Otherwise, they may cause deterioration or discoloration.

**Do not apply heat to the product.**

This may cause deterioration or discoloration.

**Discoloration of resin**

Resin materials are used in external components of the product. Carefully selected materials are used; however, discoloration may occur for reasons such as natural deterioration or the adherence of drug solutions.

To ensure use of EURUS for as long as possible, immediately wipe off any drug solutions adhered and avoid sunlight.

**Do not place objects other than a human being on the seat.**

This may cause deformation, tears, or corrosion of the leather.

**Check the operation of the doctor table**

Moving the doctor table upward/downward without releasing the brake may cause damage to the product.

Be sure to release the brake first by pressing the brake release switch. Then, move the doctor table upward/downward.

**Precautions when using the cart**

Pay attention not to collide with peripheral equipment. The leather of the chair may rip at the tip of the handpiece or the product may be damaged.

If you do not follow the instructions below, the product may be damaged or there is a risk that objects on the top will crash to the floor.

(Do not move it in rough and vigorous way. /Hold the handle to move it. /Do not lift the cart with the handle. /Do not place any object weighing 3 kg or more. /Do not sit on the cart or step on the cart base.)

**Carefully handle handpieces/syringes.**

Handle handpieces/syringes with care to prevent dropping. Dropping them may cause damage or deformation.

**Illumination of LED indicators**

Since illumination of the LED indicators acts as a guide for chair/handpiece locking, the occurrence of mode switching, ensure that the control switches function normally as displayed before the start of work every day.

### **Check the operation of the compressor.**

This product will not work unless air is supplied. Switch on the compressor before operating this product.

### **Pay attention to prevent the use of water other than tap water.**

This product is intended for use with tap water, purified water, distilled water, or pure water; use of water other than those mentioned above may lead to failure.

If the product breaks down due to the use of unspecified water, it will not be covered by the guarantee.

### **Action to take in the case of a water leak**

In the event of a water leak, close the main water valve, turn off the main switch and breaker for devices used in the clinic, and contact your local authorized Belmont dealer.

### **Use this product only for dental treatment.**

This product is a dental unit and patient chair used for dental treatment.

Only a dentist and dental staff are allowed to use this product.

### **Chair's weight limit**

The chair may rise slowly if a person weighs around the maximum lifting capability.

[Reference] Weight limit

4 Product Specification, 4-1 Technical Data [Pages 43]

### 3-2 Precautions for Using Synthetic Leathers

#### Adherence of clothing dye

To clean and disinfect the synthetic leathers, wipe the surface with a soft cloth or paper towel moistened with FD360 manufactured by Dürr, and then wipe it with a dry cloth.

Dye may migrate from clothes or belts to the synthetic leathers of the product. If dye is adhered, wipe gently with a soft cloth impregnated with a neutral detergent diluted to about one-tenth with water as soon as possible to prevent penetration. Next, wipe with water and then thoroughly with a dry cloth.

#### Pay attention to prevent deterioration and dye migration due to contact.

Contact with other resin materials, coated products, solvents, and adhesive tapes may cause changes in the surface gloss, cracks, deformation or abrasion.

Dye may migrate from newspapers or printed matters to the product.

Dye may migrate from printed clothes such as T-shirts or denim clothes to the leathers of this product.

Adherence of benzene, nail polish remover, alcohol, or oil may cause discoloration, surface dissolution, changes in gloss, hardening, softening or abrasion.

Use of a bleaching agent or a sheet cleaned by bleach may cause changes in gloss or discoloration.

Placing the product near a heat source such as a heater may cause deformation or discoloration.

Shield the product from direct sunlight by using a curtain. Direct sunlight may cause surface change, shrinkage, discoloration or fading.

Placing a heavy object on the product for a long time may leave a mark or wrinkle.

## 4 Product Specifications

### 4-1 Technical Data

#### 4-1-1 Specification Variations

S6

		S6H	S6P	S6CH	S6CP	S6CDH	S6CDP
Chair	Contour						
	Folding legrest	<input type="radio"/>	<input type="radio"/>	<input type="radio"/>	<input type="radio"/>	<input type="radio"/>	<input type="radio"/>
Cuspidor unit	Chair mount	<input type="radio"/>	<input type="radio"/>	<input type="radio"/>	<input type="radio"/>	<input type="radio"/>	<input type="radio"/>
Vac Pac unit	Chair mount	<input type="radio"/>	<input type="radio"/>	<input type="radio"/>	<input type="radio"/>	<input type="radio"/>	<input type="radio"/>
Doctor unit delivery	Base mount	<input type="radio"/>	<input type="radio"/>				
	Cart			<input type="radio"/>	<input type="radio"/>		
	Cabinet delivery					<input type="radio"/>	<input type="radio"/>
Instrument delivery	Holder	<input type="radio"/>		<input type="radio"/>		<input type="radio"/>	
	Place holder		<input type="radio"/>		<input type="radio"/>		<input type="radio"/>



## 4 Product Specifications

### 4-1-2 S6

Model	<p>Doctor unit            AU-ER6-BM (Base mount)            AU-ER-CT (Cart)            AU-ER-CD (Cabinet delivery)            Cuspidor unit            AU-ER6-CM*            Vac Pac unit            AU-ER6-VP*            Chair            AC-ER6-BP* (Base mount Power Headrest)            AC-ER6-BD* (Base mount Manual Headrest)            AC-ER6-CP* (Cart Power Headrest)            AC-ER6-CD* (Cart Manual Headrest)            (* represents single or multiple strings or numbers. )</p>
Classification for protection against electric shock	Class I Equipment
Classification according to the degree of protection against electric shock	Type B Applied Parts (handpiece/syringe/chair upholstered parts/armrest)
Classification according to the degree of protection against ingress of water or particulate matter	Foot controller IPX1
Rated voltage	AC230 V
Power frequency	50/60 Hz
Power input	5.5 A

## 4 Product Specifications

Fuse	Fuse holder Primary circuit: 8A / 250V (Interrupting capacity: 80A / 250VAC) Operating speed: Time lag Size: 5.2 × 20 mm
	Secondary circuit for 24V / 6.5A line 10A / 250V (Interrupting capacity: 1500A / 250VAC) Operating speed: Time lag Size: 5.2 × 20 mm
	Secondary circuit for 24V / 5A line 6.3A / 250V (Interrupting capacity: 1500A / 250VAC) Operating speed: Time lag Size: 5.2 × 20 mm
	Secondary circuit for 14V / 5A line 6.3A / 250V (Interrupting capacity: 1500A / 250VAC) Operating speed: Time lag Size: 5.2 × 20 mm
	Secondary circuit for handpiece water heater 6.3A / 250V (Interrupting capacity: 1500A / 250VAC) Operating speed: Time lag Size: 5.2 × 20 mm
	Secondary circuit for 6-way syringe/cup water supply and water heater 6.3A / 250V (Interrupting capacity: 1500A / 250VAC) Operating speed: Time lag Size: 5.2 × 20 mm
	Power board for NLX Plus/NLX Nano/MX2/MCX 5A / 250V (Interrupting capacity: 100A / 250VAC) Operating speed: Time lag Size: $\varnothing$ 8.35 mm
	Foot controller control board 0.315A / 32V (Interrupting capacity: 1.2A / 32VAC) Operating speed: Normal operation Size: 1.6 × 0.8 mm
	Chair control board 1.25A / 250V (Interrupting capacity: 1500A / 250VAC) Operating speed: Interrupting Size: 5.2 × 20 mm
	AC/DC power circuit board 2.0A/250V (Interrupting capacity: 100A/300VAC) Operating speed: Time lag Size: 8.5x8.5x4 mm

## 4 Product Specifications

Operation mode	Non-continuous operation (motor) Maximum operating time, 3 minutes DUTY 1:15														
Weight	<table> <tr> <td>Cuspidor unit</td> <td>40 kg</td> </tr> <tr> <td>Doctor unit</td> <td></td> </tr> <tr> <td>Base mount</td> <td>32 kg</td> </tr> <tr> <td>Cart</td> <td>25 kg</td> </tr> <tr> <td>Cabinet delivery</td> <td>35 kg</td> </tr> <tr> <td>Vac Pac</td> <td>20 kg</td> </tr> <tr> <td>Chair</td> <td>160 kg</td> </tr> </table>	Cuspidor unit	40 kg	Doctor unit		Base mount	32 kg	Cart	25 kg	Cabinet delivery	35 kg	Vac Pac	20 kg	Chair	160 kg
Cuspidor unit	40 kg														
Doctor unit															
Base mount	32 kg														
Cart	25 kg														
Cabinet delivery	35 kg														
Vac Pac	20 kg														
Chair	160 kg														
Main air pressure	0.5 MPa														
Main water pressure	0.2 MPa														
Chair Initial height/stroke	505 mm/265 mm														
Chair raising and lowering mechanism	Electrohydraulic														
Headrest	Electrohydraulic Manual														
Backrest	Electrohydraulic														
Seat	Backrest-linked tilt mechanism														
Armrest	Left fixed/Right rotated Angle of rotation 180°														
Upholstered parts	Synthetic leather														
Control switch	Stick switch														
Usage environment	Temperature 0°C to 40°C Humidity 10% to 95% (No condensation) Atmospheric pressure 700 to 1060 hPa														
Transportation/storage environment	Temperature -20°C to 70°C Humidity 10% to 95% (No condensation) Atmospheric pressure 700 to 1060 hPa														
Weight limit	Doctor table 3 kg Assistant tray 1.5 kg Chair 165 kg														
Adaptation to high-oxygen environment	The product is not suitable for use in a high-oxygen environment.														

Refer to the rating plate for the capacity of power supply.

The specification is subject to change without notice.

## 4 Product Specifications

Dimensional drawing (standard values are provided)

Base mount  
Cuspidor

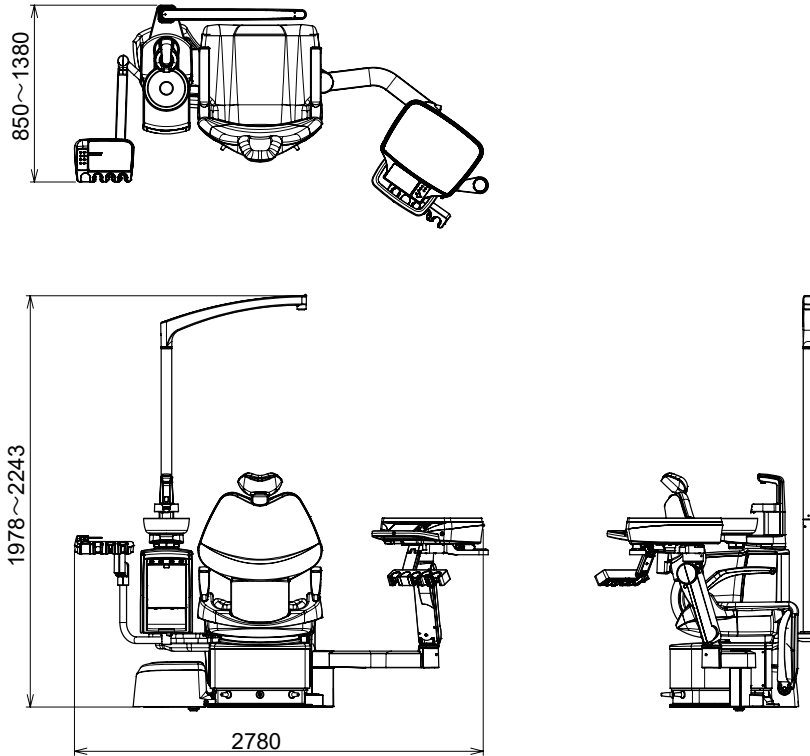

Base mount  
Vac Pac

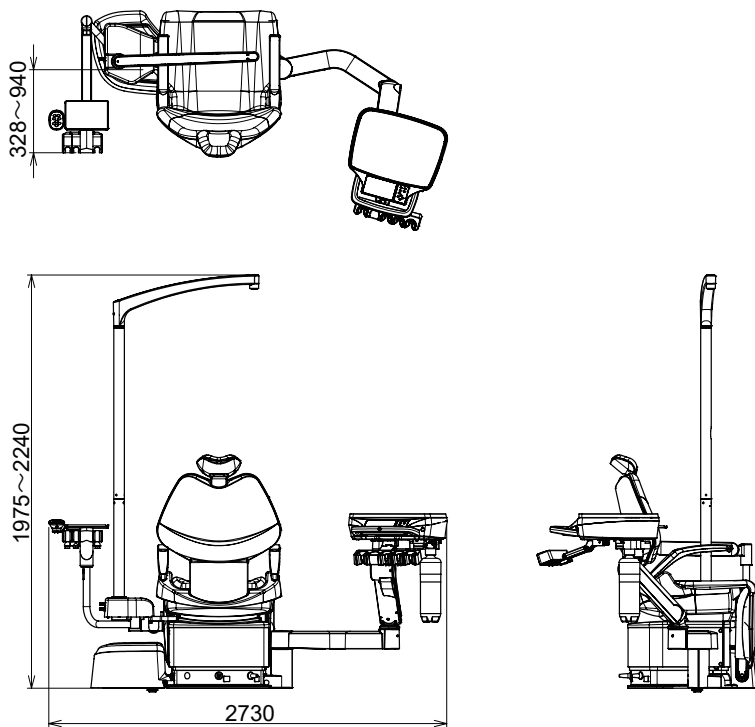

Unit: mm  
Tolerance in dimensions:  $\pm 10\%$

The specification is subject to change without notice.

# 4 Product Specifications

Dimensional drawing (standard values are provided)

## Cart Cuspidor

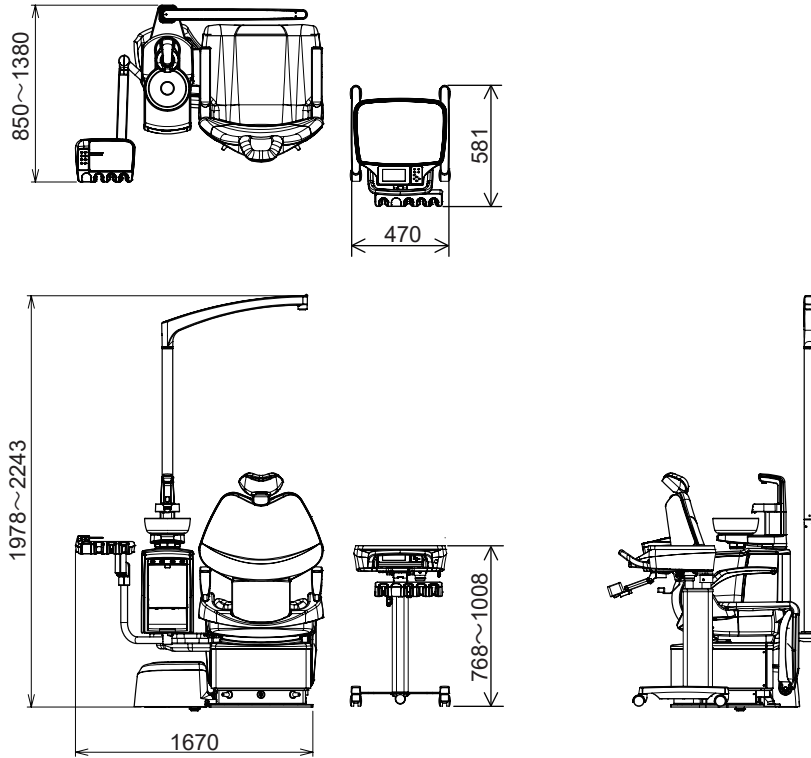

## Cart Vac Pac

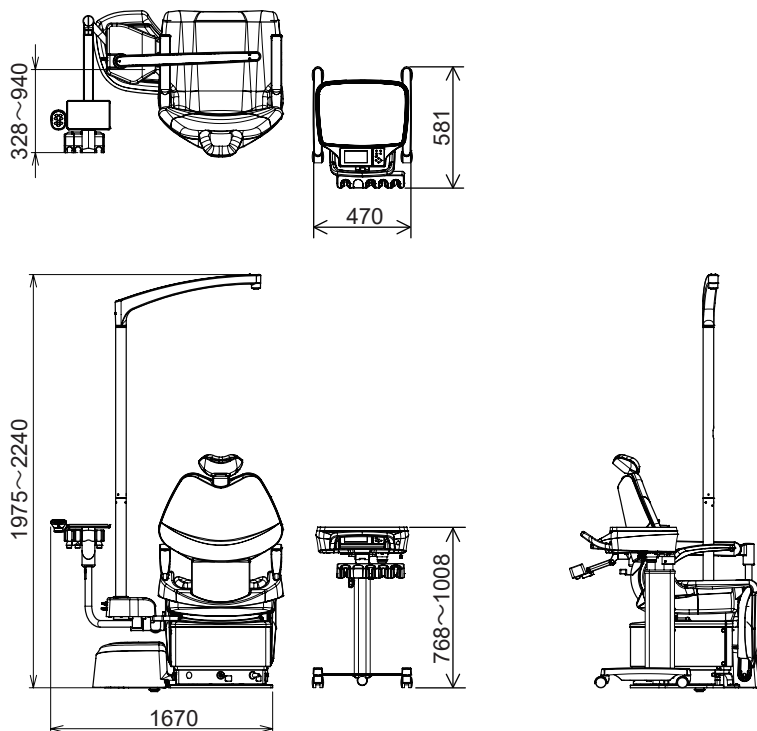

Unit: mm  
 Tolerance in dimensions: ±10%

The specification is subject to change without notice.

# 4 Product Specifications

Dimensional drawing (standard values are provided)

## Cabinet delivery Cuspidor

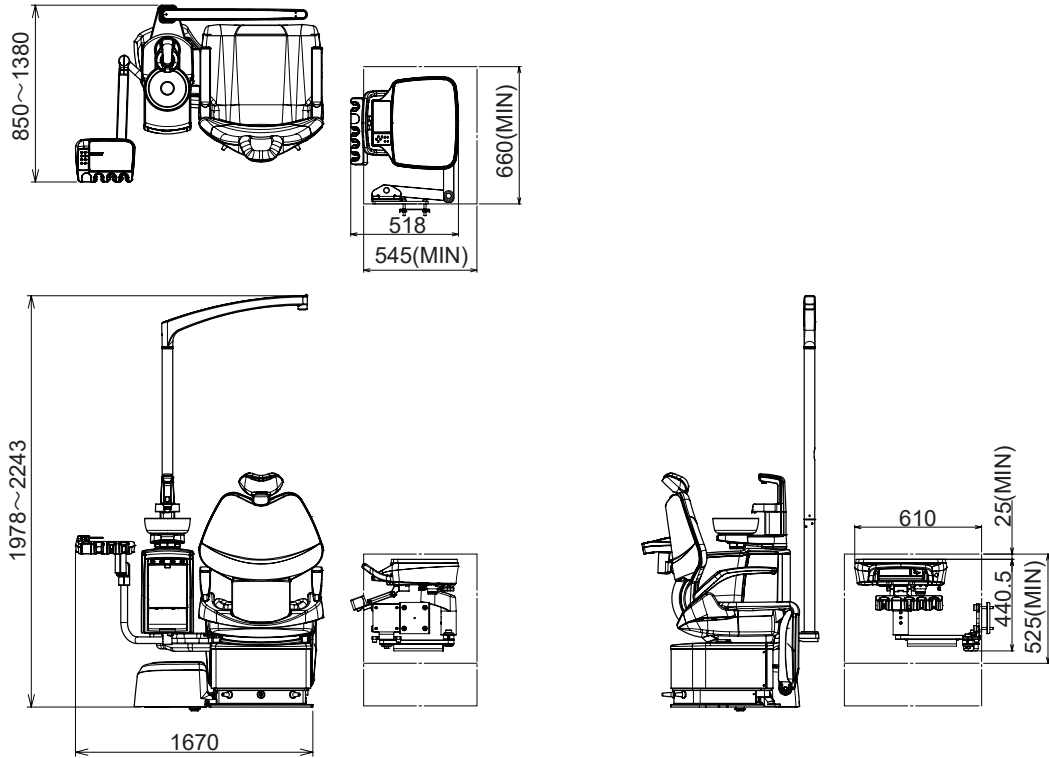

## Cabinet delivery Vac Pac

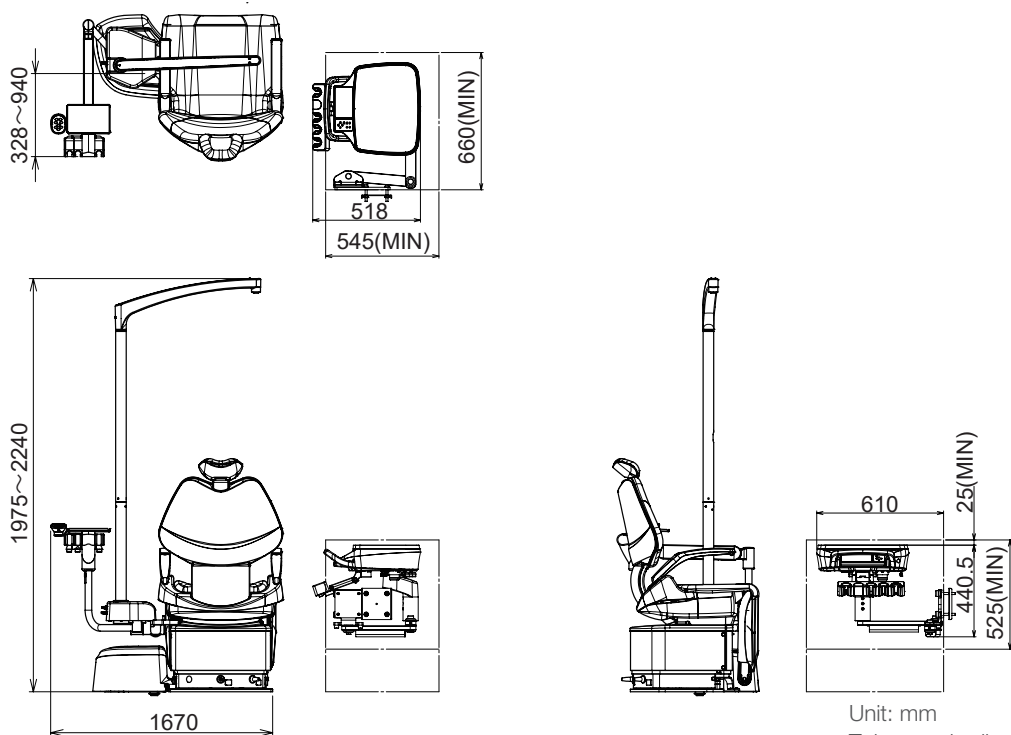

Unit: mm  
Tolerance in dimensions: ±10%

The specification is subject to change without notice.

# 4 Product Specifications

## Chair

Dimensional drawing (standard values are provided)

Headrest: Electrohydraulic  
Base mount

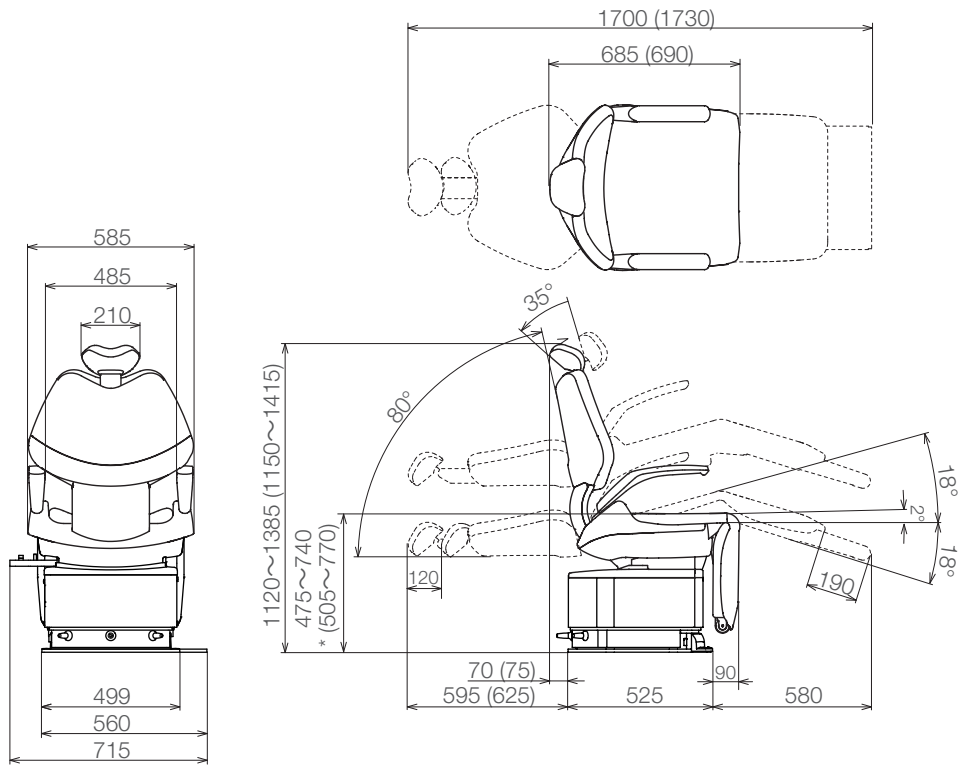

Cart / Cabinet delivery

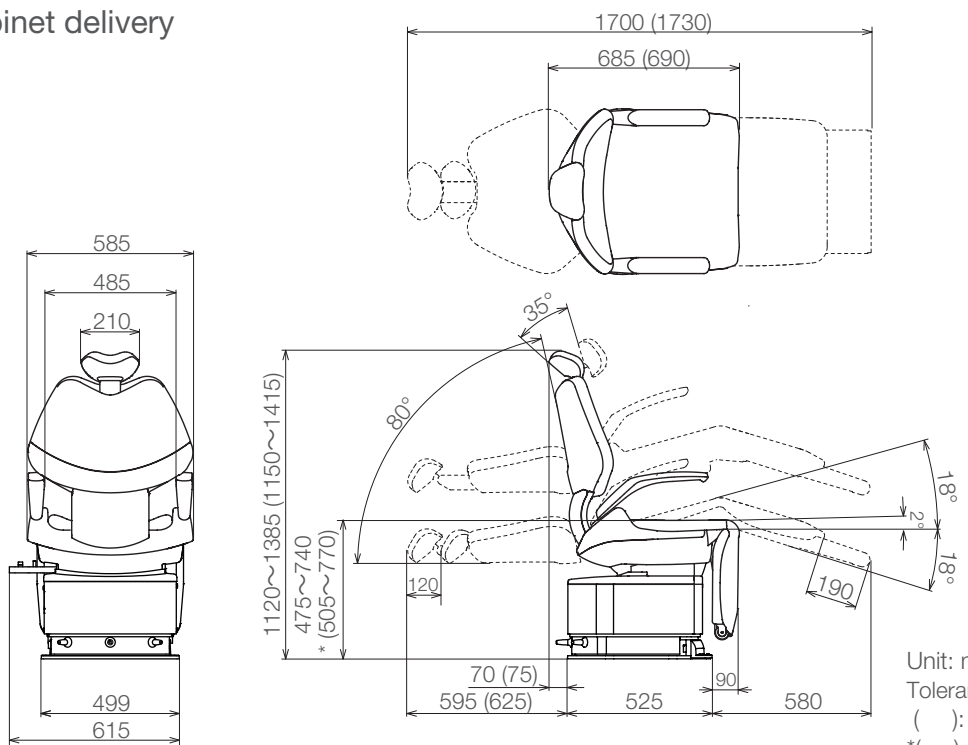

Unit: mm  
Tolerance in dimensions: ±10%  
( ): High backrest  
\*( ): Flat seat

The specification is subject to change without notice.

# 4 Product Specifications

Headrest: Manual  
Base mount

Dimensional drawing (standard values are provided)

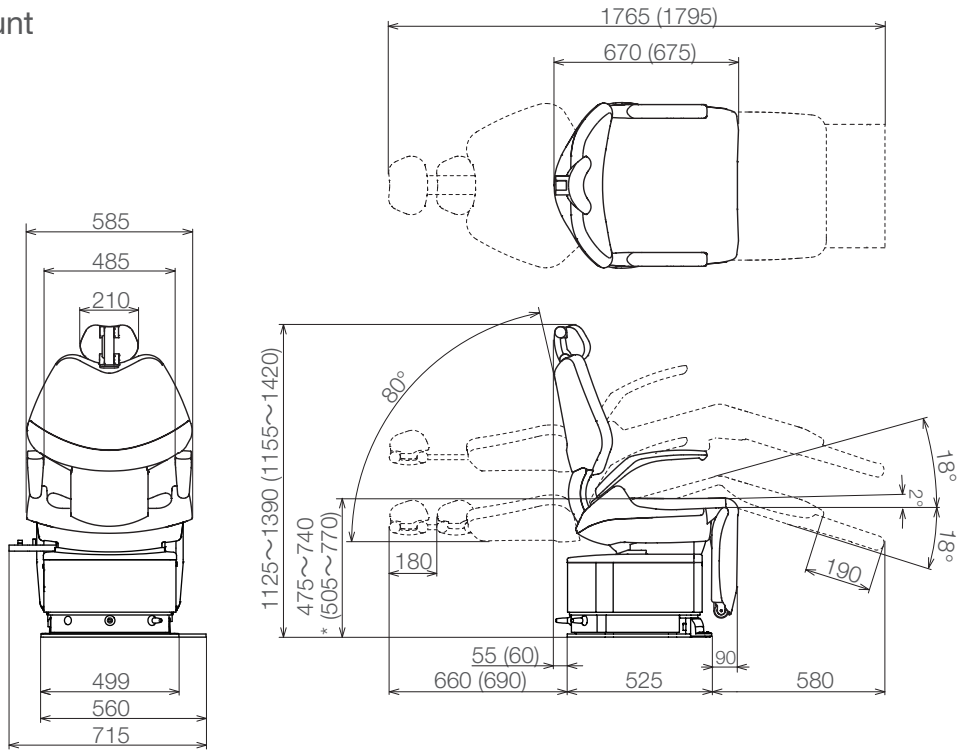

Cart / Cabinet delivery

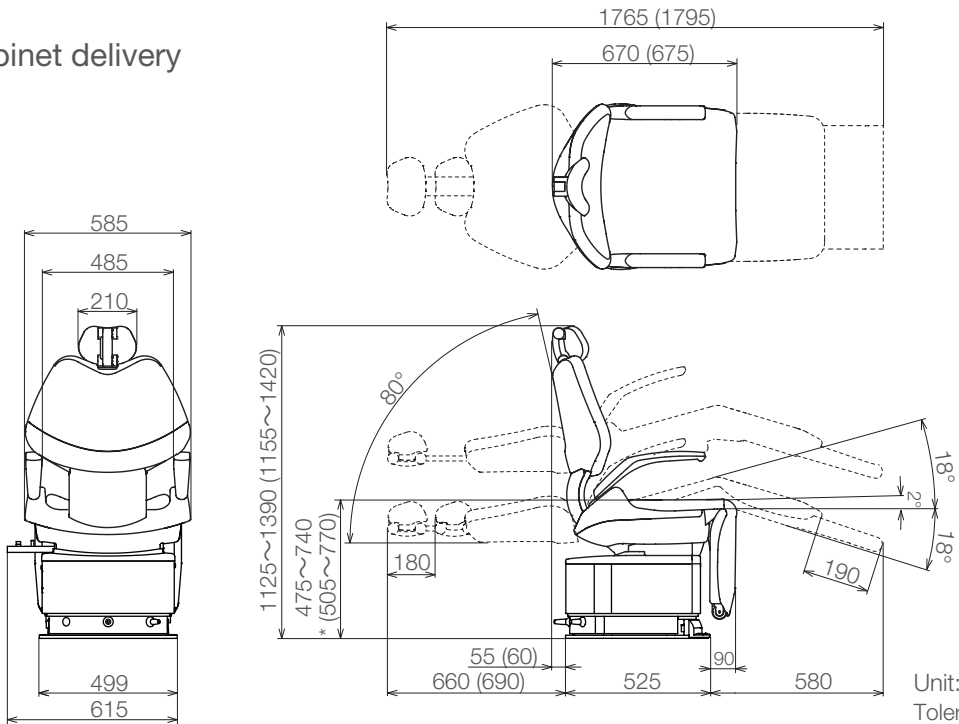

Unit: mm  
Tolerance in dimensions: ±10%  
( ): High backrest  
\*( ): Flat seat

The specification is subject to change without notice.



## 4-2 System Overview

Base mount  
Cuspidor

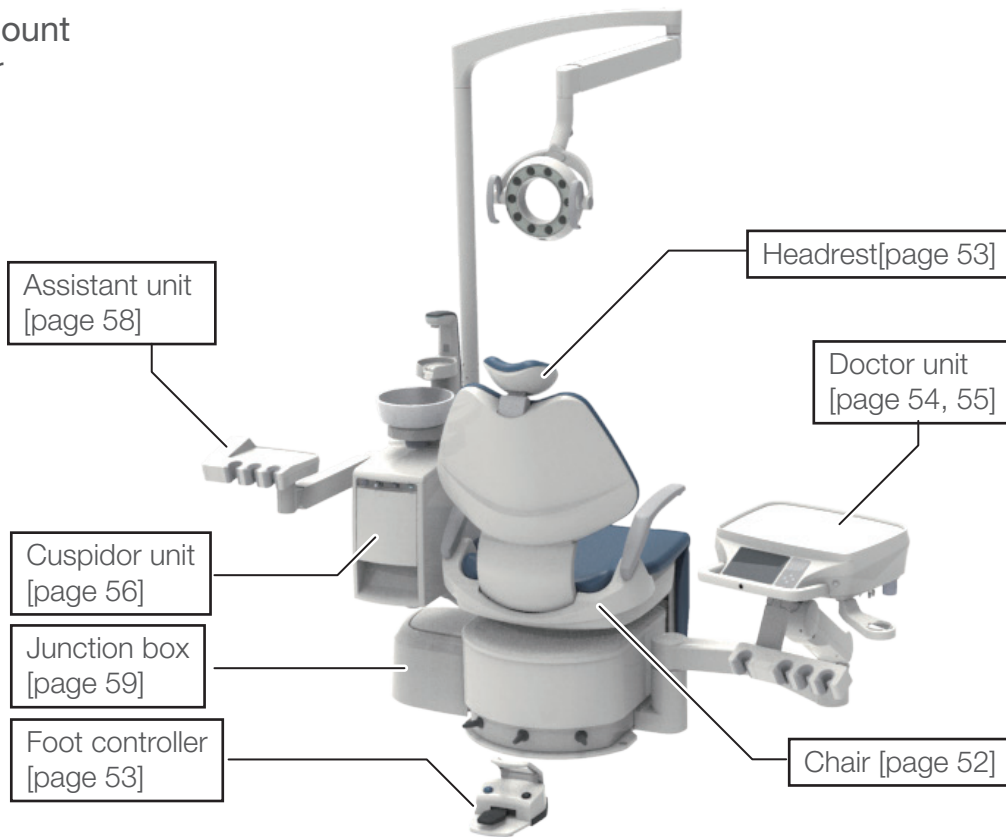

Base mount  
Vac Pac

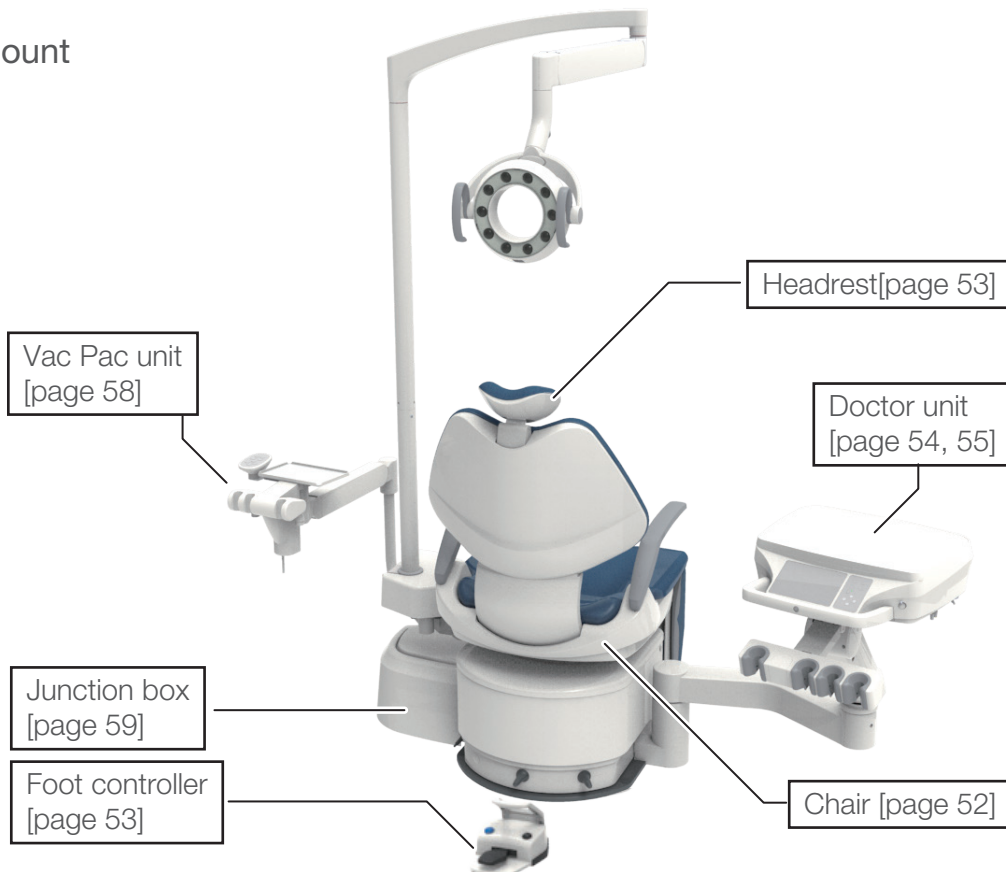

## 4 Product Specifications

### Cart Cuspidor

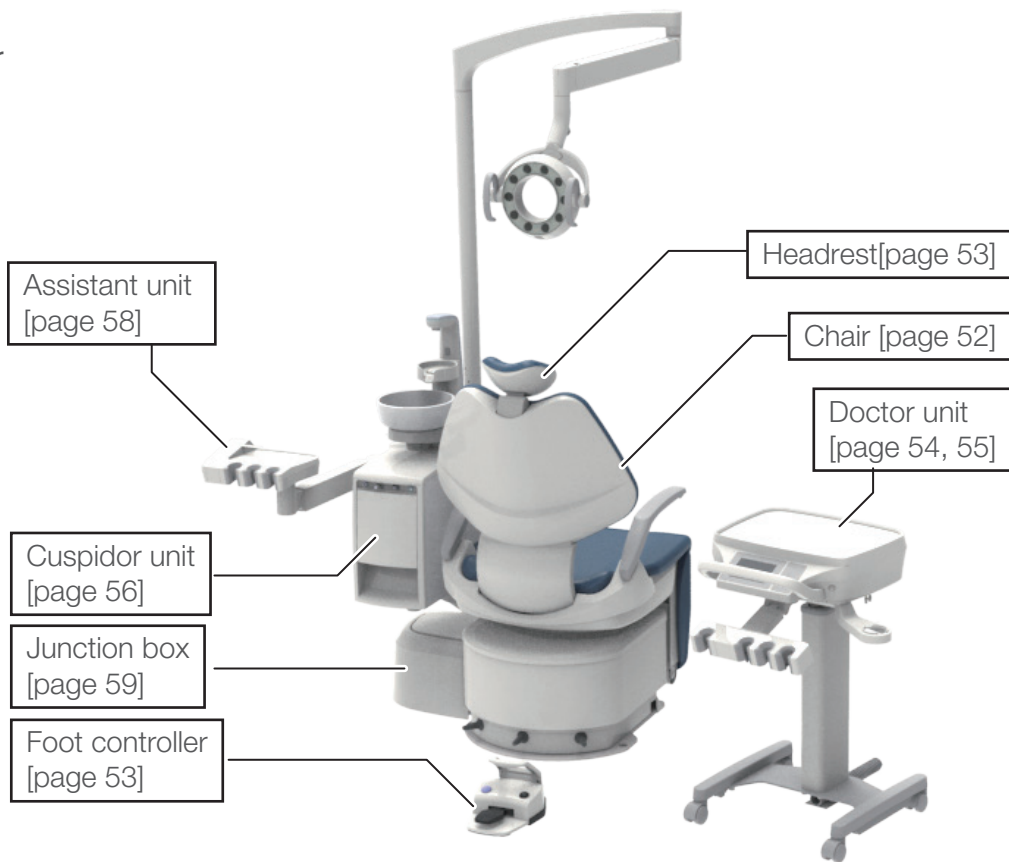

### Cart Vac Pac

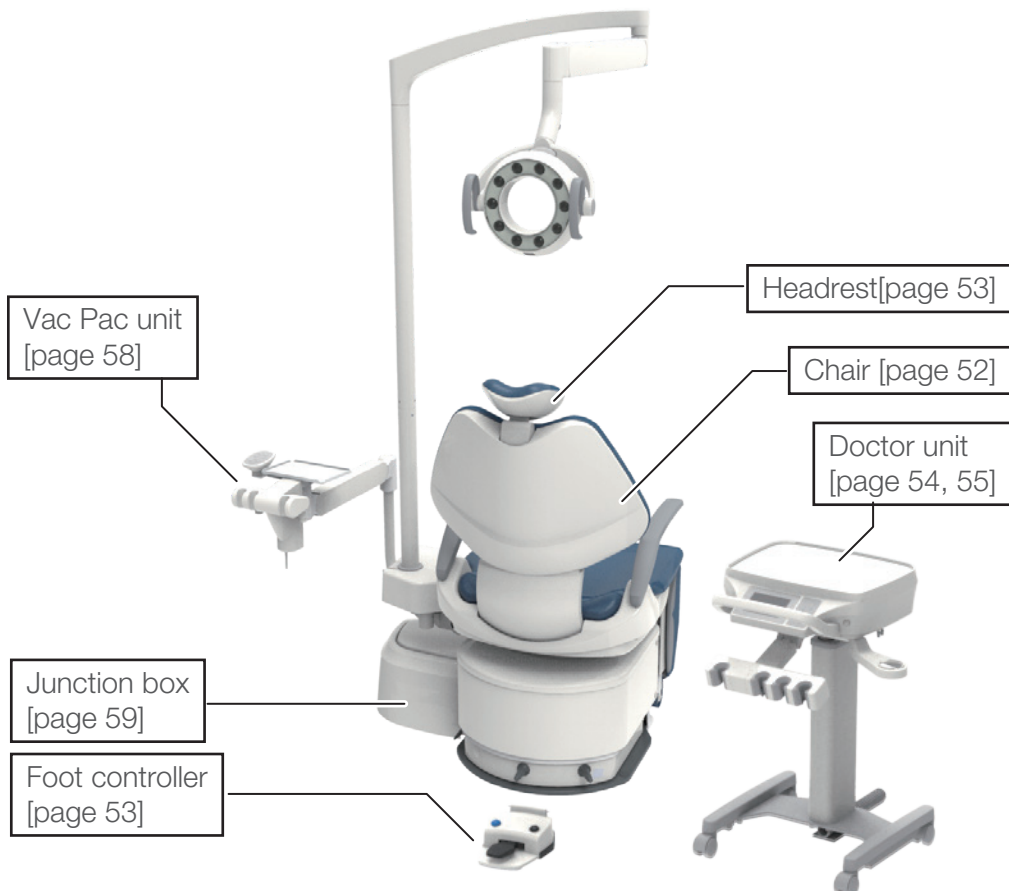

## 4 Product Specifications

### Cabinet delivery Cuspidor

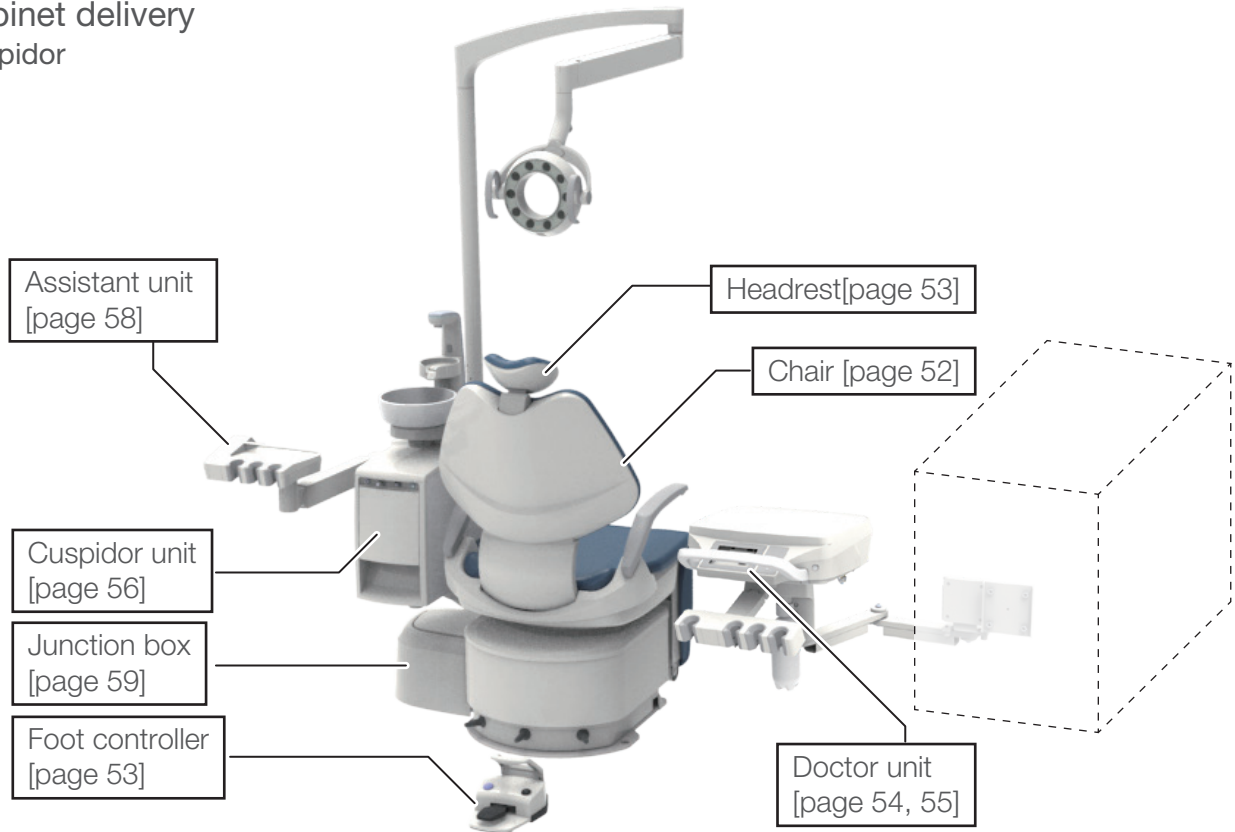

### Cabinet delivery Vac Pac

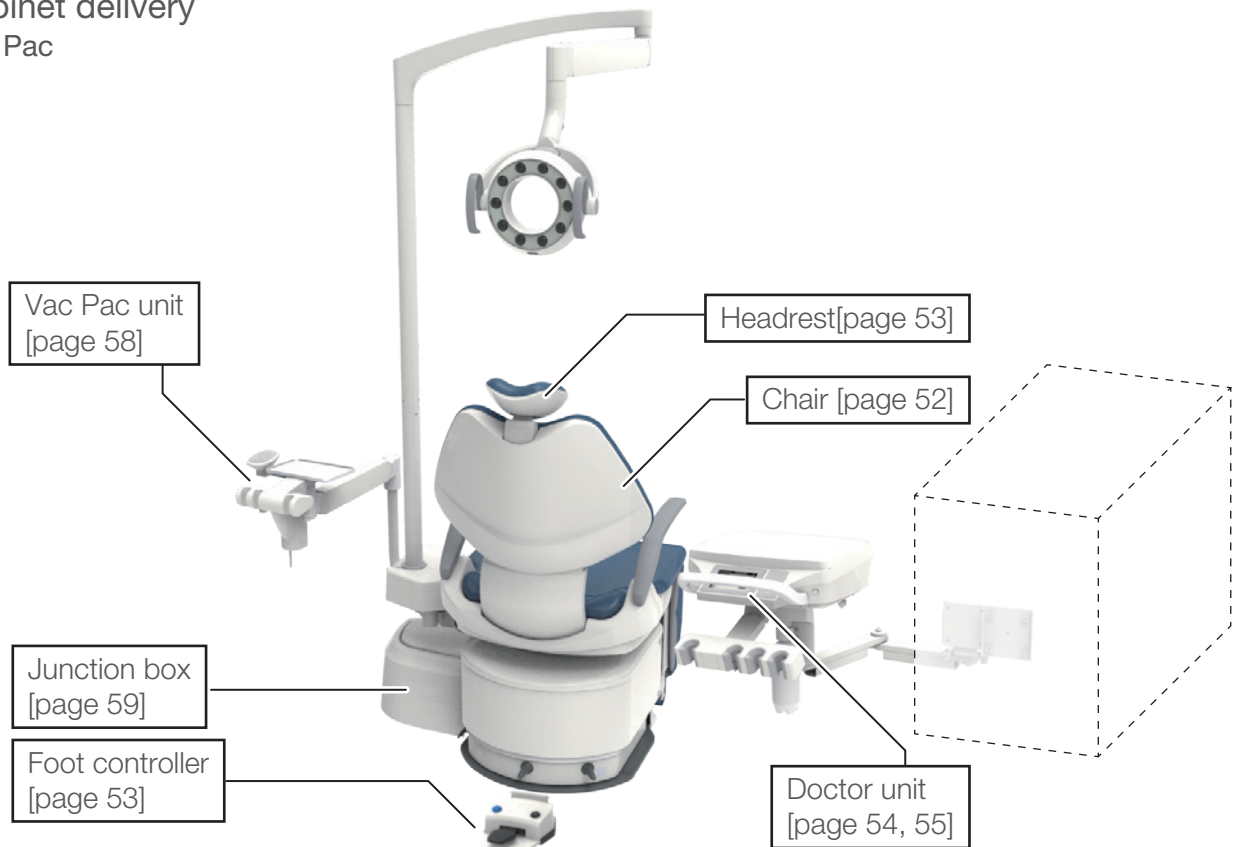

## 4 Product Specifications

### 4-3 Name of Each Part

#### 4-3-1 Chair

The headrest may differ according to the specification selected.

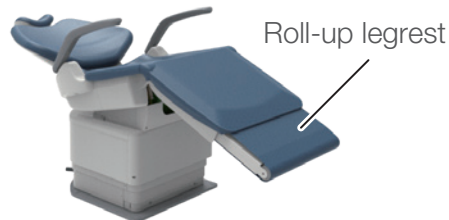

(Three different stick switches are available: For the headrest, for the chair [manual], and for the chair [auto])

The position or availability of the stick switch may differ according to the specification selected.

### 4-3-2 Headrest

Headrest (electrohydraulic)



### Headrest (manual)

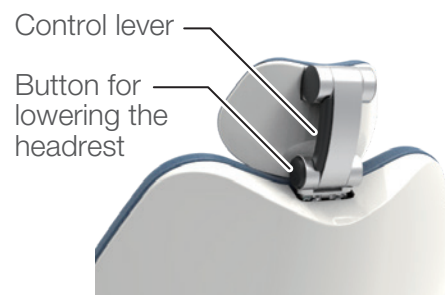

### 4-3-3 Foot Controller (wired/wireless)

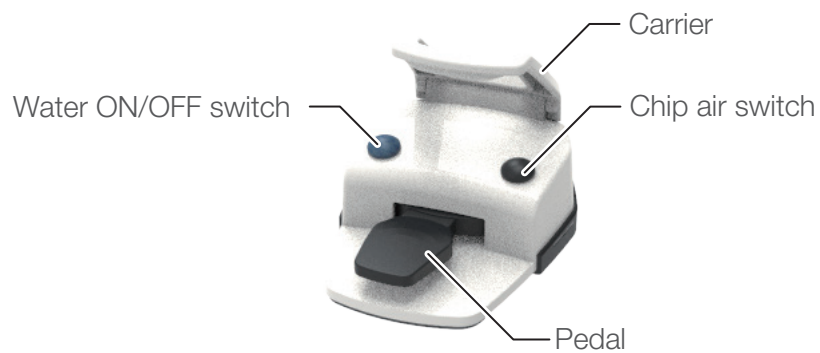

## 4 Product Specifications

### 4-3-4 Doctor Unit

#### 4-3-4-1 Doctor Unit Delivery

##### Base mount

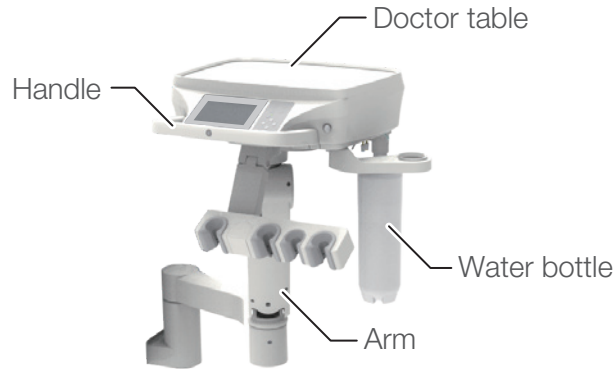

##### Cart

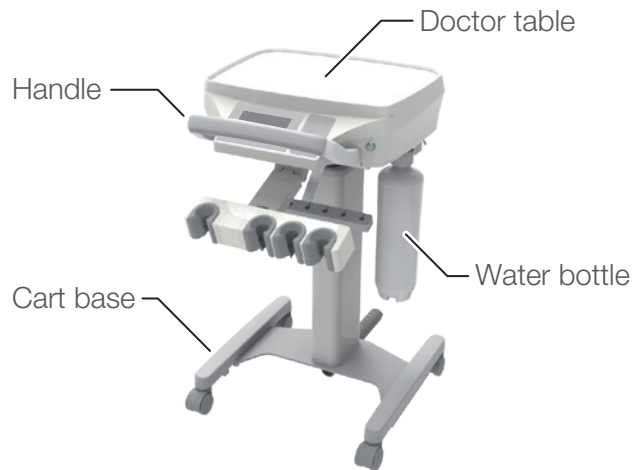

##### Cabinet delivery

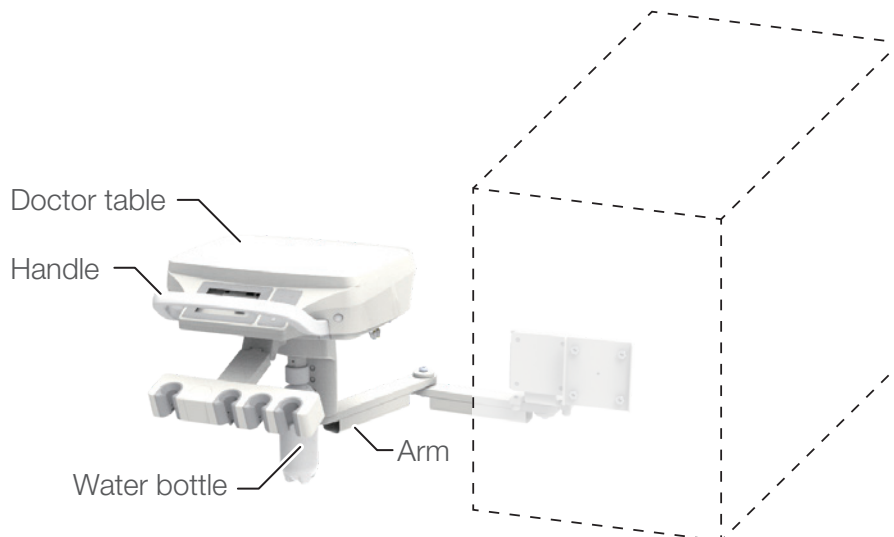

## 4 Product Specifications

### 4-3-4-2 Instrument Delivery

Base mount

Holder

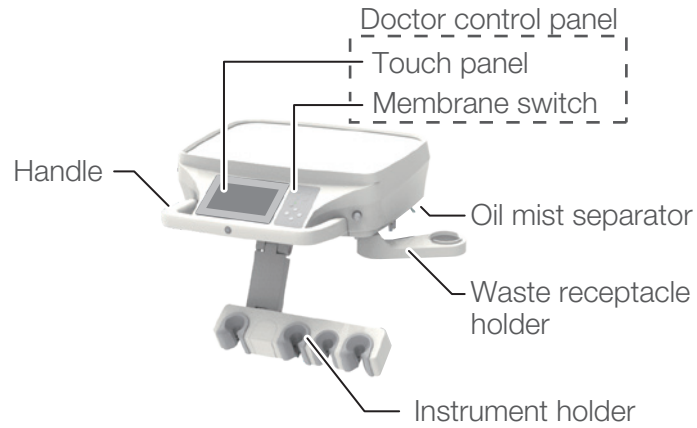

Place holder

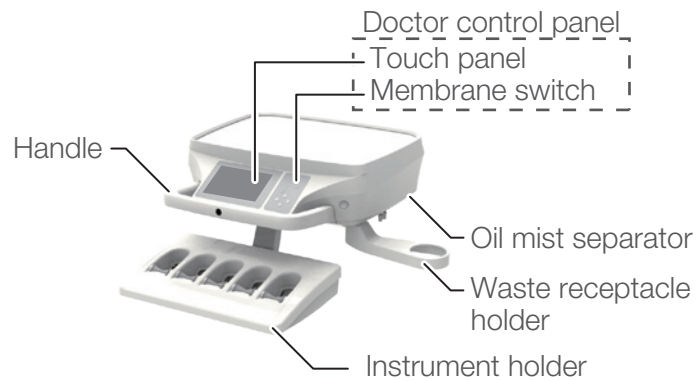

## 4-3-5 Cuspidor Unit

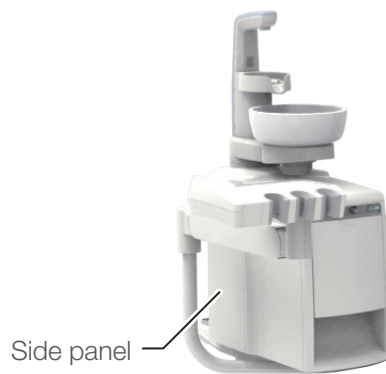
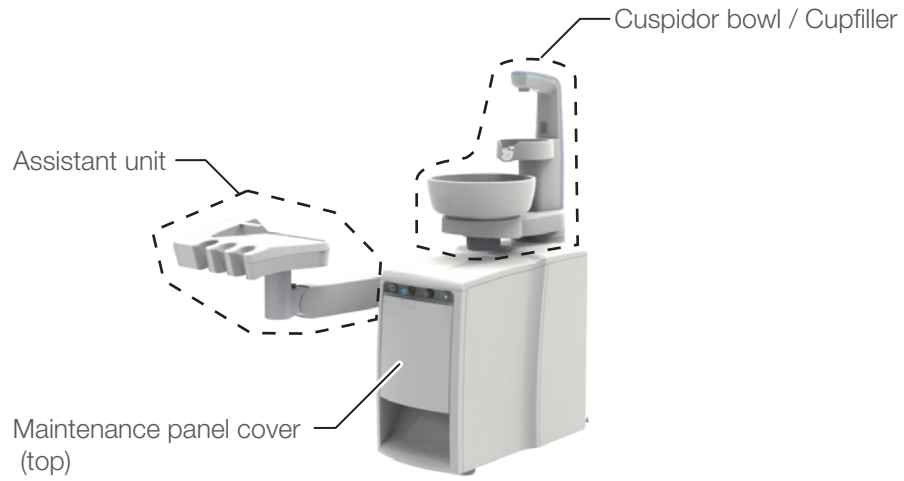

## 4-3-5-1 Cuspidor bowl/Cupfiller

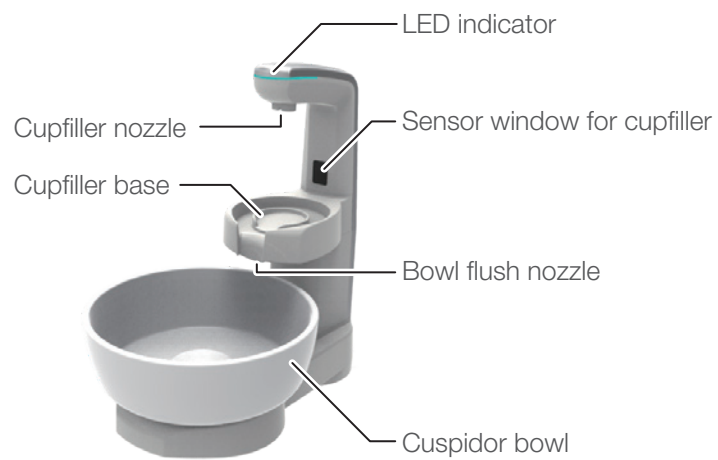



## 4-3-5-2 Maintenance Panel

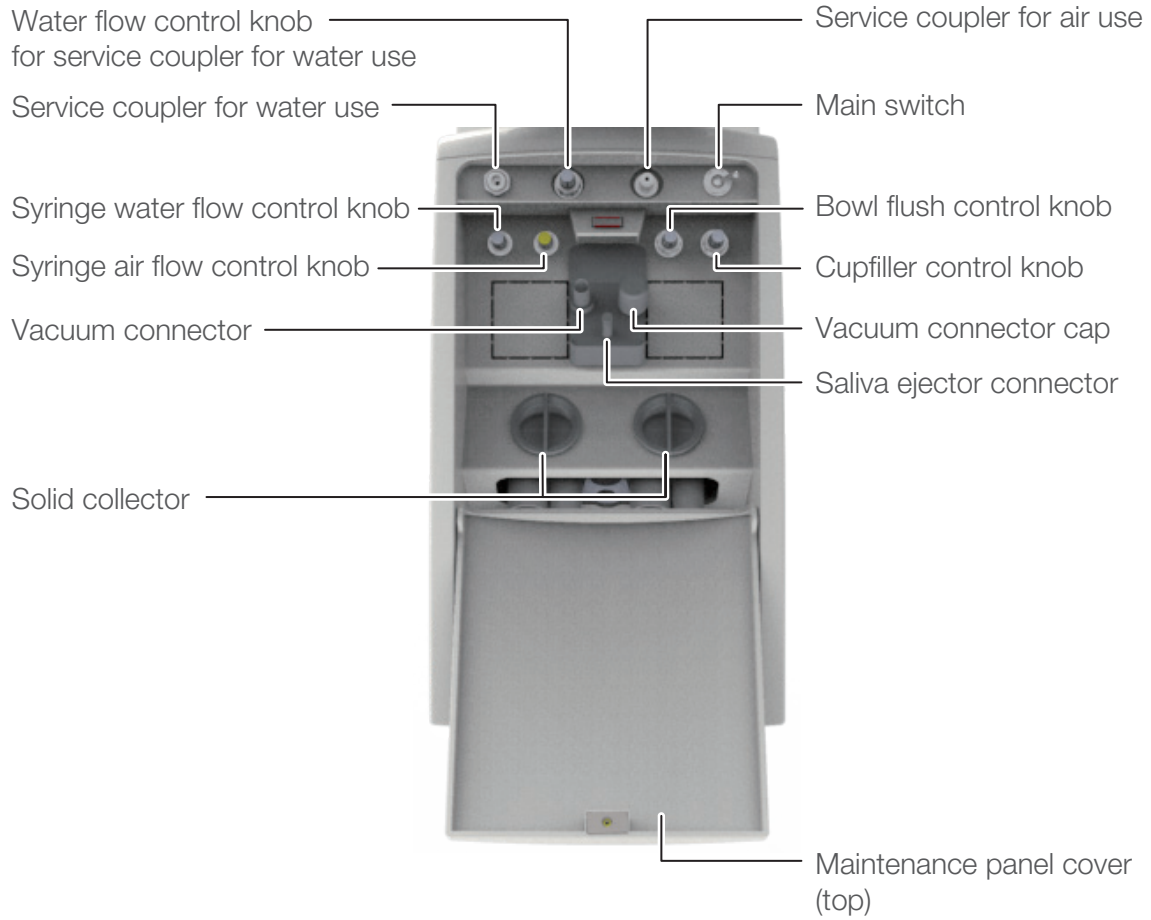

### 4-3-6 Vac Pac Unit

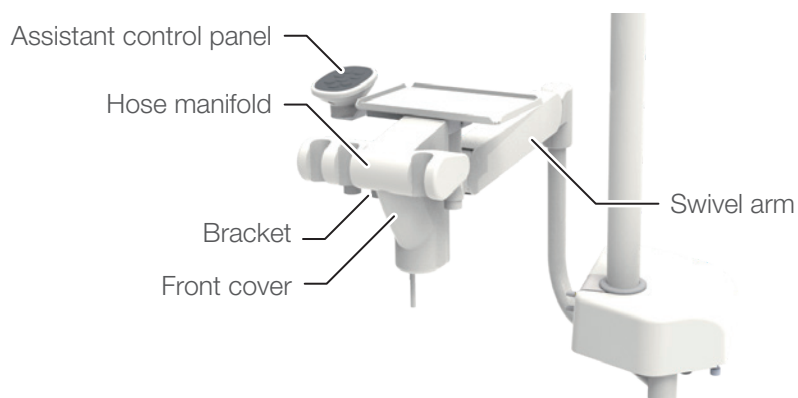

Refer to the DURR products' instructions for use for operating procedures.

### 4-3-7 Assistant Unit

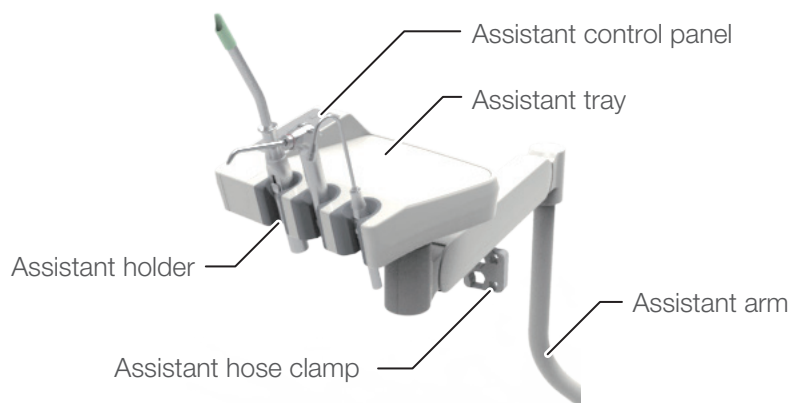

## 4-3-8 Junction Box

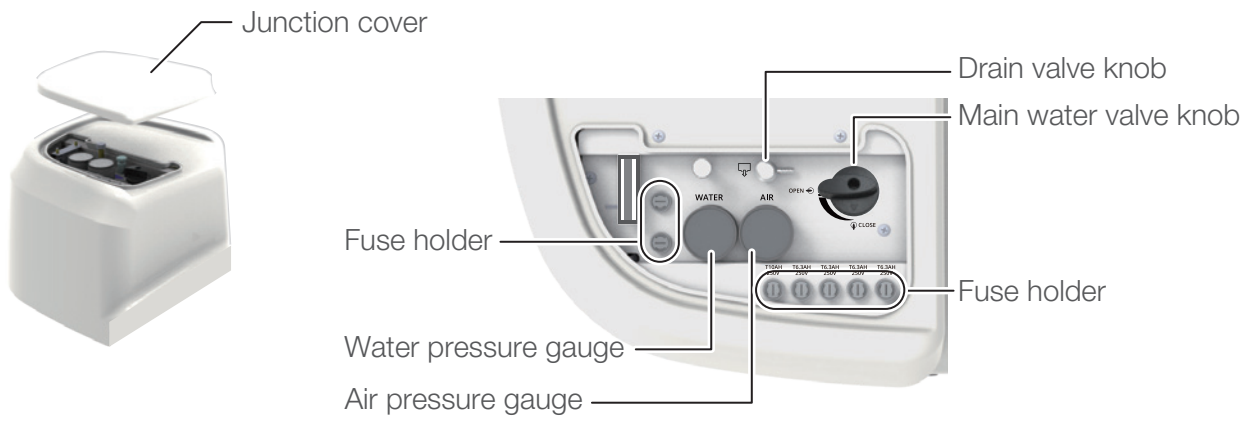

## 5 Operation

### 5-1 Preparation Before Use

#### 1 Open the main water valve

Remove the junction cover. Turn the main water valve knob clockwise to lay it on its side.



Main water valve knob



The valve is closed.



The valve is open.

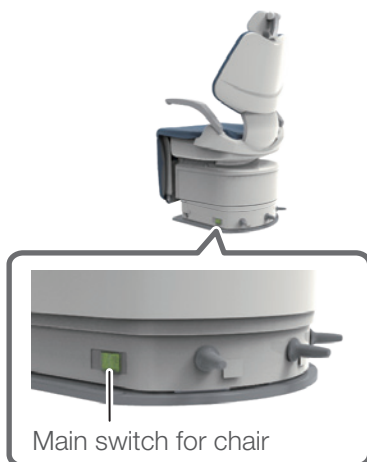

#### 2 Turn on the power for chair

Press the main switch for chair.

\* When turns on, it will light up.

**⚠ CAUTION**

Operate the main switch for chair by hand.

### Cuspidor

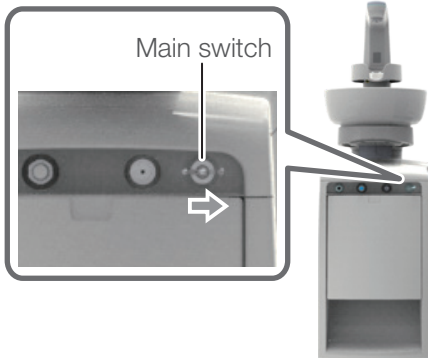

### Vac Pac

In the case of a Vac Pac unit, the main switch is located under the doctor table.

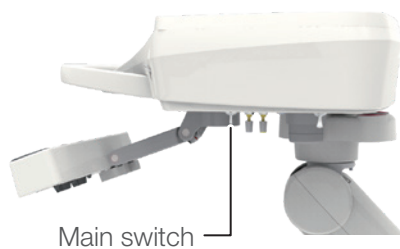

## 3 Switch on EURUS.

Turn the main switch to the right ( I )

Nothing should be placed on the cupfiller base when the main switch is turned on. Water may not be supplied normally during cupfiller operation.

When turning on the main switch, sensitivity of touch panel will be initialized. Do not turn on the power while touching the panel by fingers.

Turning on the power while touching the panel may lead to the reduction of the sensitivity of the panel.

If the detection is incorrect, turn off the power and wait for approx. 5 seconds. Then, turn on the power again.

## CAUTION

Operate the main switch by hand.

Peel off the film attached to the touch panel before initial use. Using the touch panel with the film attached may lead to incorrect operation, resulting in injury.

## 4 Confirm the startup screen and flush the retained water

Turn on the main switch. The  mark is displayed on the touch panel, the startup sound is heard, and the program version information is displayed for several seconds.

The program version information differs depending on the month of purchasing (manufacturing) and specifications.

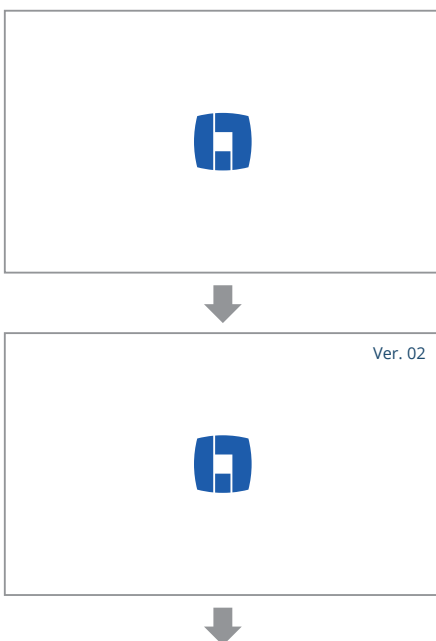

## 5 Operation

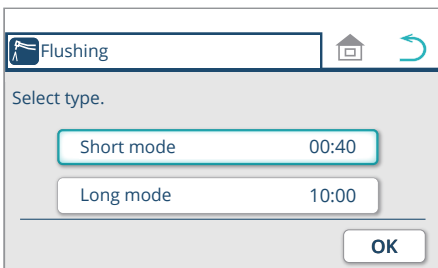
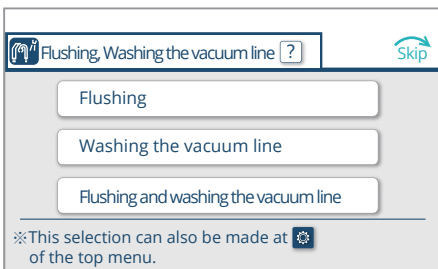
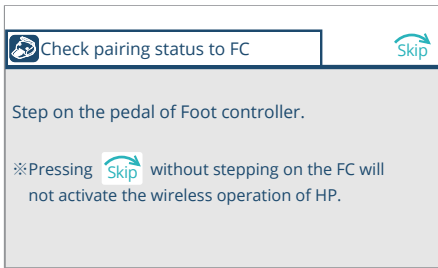

For Vac Pac unit type

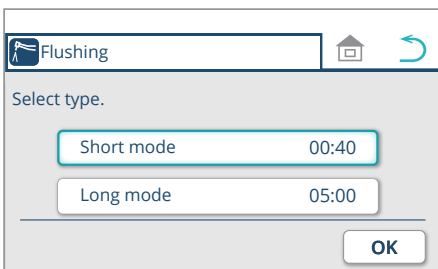

Without washing function for vacuum line

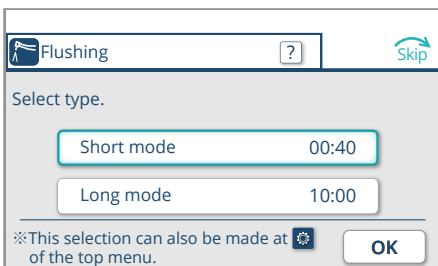

Hold down the pedal of the wireless foot controller until the flushing screen appears.

If it does not happened while holding down the pedal of the foot controller, refer to the "Foot controller (wired/wireless)" [pages 129 to 132].

\* The wireless pairing screen does not appear if the foot controller is wired.

Press the 'Flushing' switch.

If the washing function for vacuum line is not equipped, the screen shown in the left figure does not appear. The screen titled "Without washing function for vacuum line" will be displayed.

The flushing screen is displayed.

Perform flushing, referring to "Selection and implementation of flushing method" [pages 147 to 155].

\* To cancel the process, press Skip.

\* For Vac Pac unit type, the screen shown in the left figure appears.

## Home screen

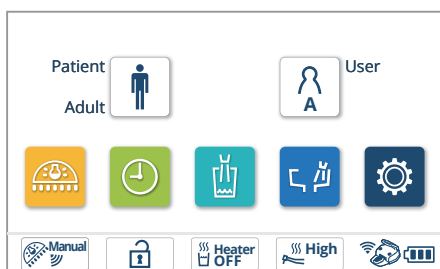



Once the flushing process is completed, the home screen is displayed.

For the description of respective switches and indications, see “Doctor’s unit operation panel” [pages 77 to 97].

## 5 Be sure to respond appropriately if an error occurs

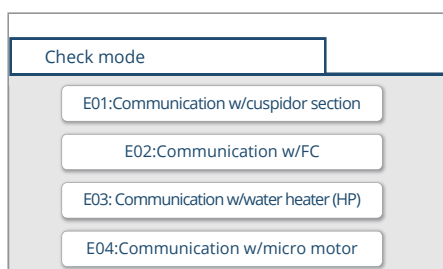
If an error occurs during the startup process, the check mode screen is displayed on the touch panel. See explanation on [pages 218 to 220], and respond appropriately according to the indicated method.



To display the next screen, press the  skip switch. If five or more errors occur, press the  skip switch to check errors other than the ones indicated on the first page.

## 6 Perform startup inspection

- ① Confirm that the discharge of retained water has been completed.
- ② Operate the switches and the foot controller to confirm that the chair and the handpieces/syringes function normally. (Connect the handpieces/syringes before performing the operation check.)

## 7 Prepare for the procedure

- ① Put a cup on the cupfiller base of the cuspidor unit.
- ② Attach the vacuum/saliva ejector tip to the vacuum/saliva ejector handpiece.



Be sure to perform maintenance inspection before use (startup inspection to confirm that the product functions normally). Operation without performing maintenance inspection may result in injury and damage to peripheral equipment.

### 5-2 After use

#### 1 Turn off the power for chair

When turned off, the light goes off.

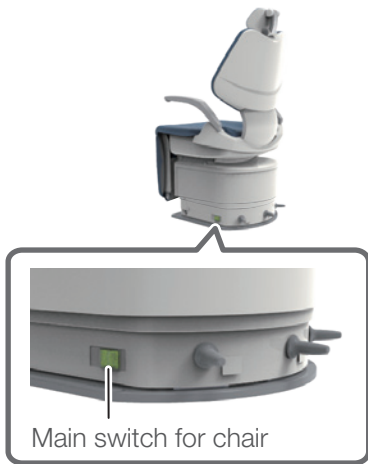

### CAUTION

Operate the main switch for chair by hand.

#### 2 Power off the unit

Push down the main switch to the left side (○).

##### Cuspidor

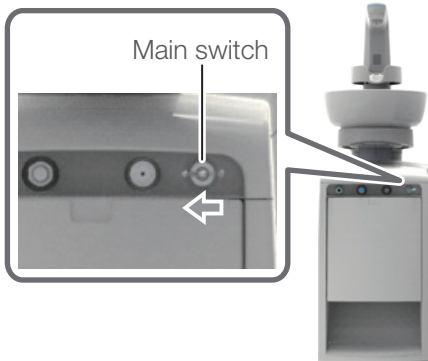

### CAUTION

Operate the main switch by hand.

##### Vac Pac

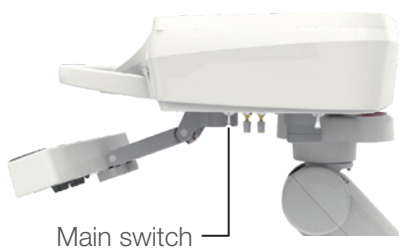



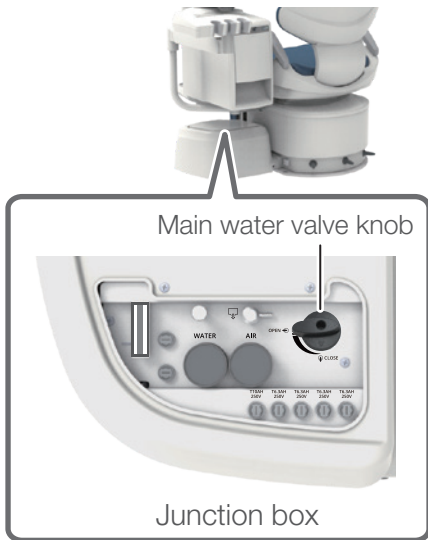

Main water valve knob



The valve is open.      The valve is closed.

### 3 Close the water main valve

Turn the main water valve knob counterclockwise until the knob is positioned vertically.

## ⚠ CAUTION

To prevent accidental leakage, be sure to close the main water valve at the end of day.

### 5-3 Operating the main switch for chair during treatment (when the main switch for chair is available)

Touch panel

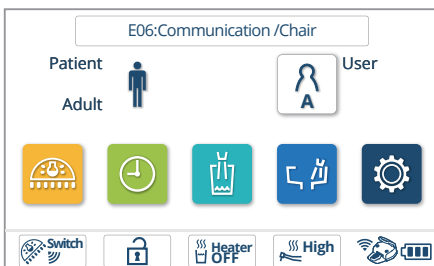

LED indicator



#### 1 Turn off the power for chair

Press the main switch for chair.

When turning off the chair, “E06: Communication with chair” is displayed on the touch panel because of the interruption of communication between unit and chair, then LED indicator of the cuspidor unit lights up in orange, which is not malfunction.

#### 2 Turn on the power for chair

Press the main switch for chair.

Press the main switch for chair when 5 seconds or more have passed after turning off the main switch for chair.

## 5-4 Raising/lowering the chair and raising/reclining the backrest (manual operation)



Stick switch for manual operation

The position and/or availability of the stick switch may differ according to the specification selected.

Doctor control panel  
Membrane switch

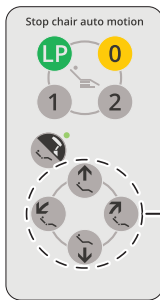

Switches for manual operation

Assistant control panel  
(Vac Pac Unit type)

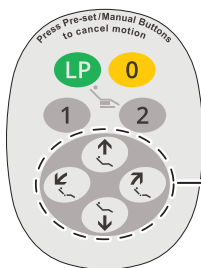

Stick switch		Operation panel switch	Operation
Pushing direction	Label indication		
			The chair is raised 
			The chair is lowered 
			The backrest is raised 
			The backrest is reclined 

\*The chair is operated while the stick switch is pushed down or the switch is pressed.

### WARNING

Before raising/lowering the chair, confirm that no human body part, limb, or obstacle is obstructing the chair.

Before reclining the backrest, confirm that the patient's arm or hand is not placed between the backrest and the seat.

Before raising the backrest, confirm that the patient's arm or hand is not placed between the backrest and the armrest.

[Reference] Precautions when a patient is seated [page 19]

# 5 Operation

## 5-5 Moving the chair to the preset position (automatic operation)



Stick switch for automatic operation

The position and/or availability of the stick switch may differ according to the specification selected.

Doctor control panel  
Membrane switch

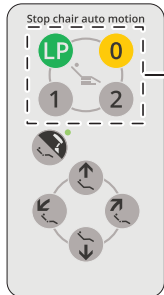

Switches for automatic operation

Assistant operation panel  
(Assistant Unit type)

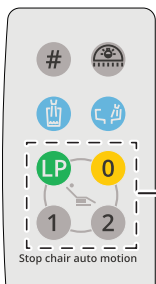

Assistant operation panel  
(Vac Pac Unit type)

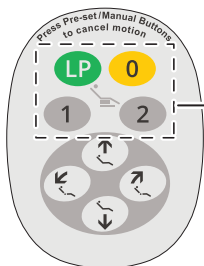

	Stick switch		Operation panel switch	Operation
	Pushing direction	Label indication		
I				The chair is moved to the preset "Treatment position 1".
II				The chair is moved to the preset "Treatment position 2".
III				The chair is moved to the preset "Entry/exit position".  By pushing again after movement completion, the headrest is housed in the case of headrest (electrohydraulic).
IV				The chair is moved to the preset "mouth rinsing position".  By pushing again after movement completion, the chair is moved to the position prior to the "mouth rinsing position".

Do not hold down the preset switches **1** or **2**, automatic return switch **0**, or last position switch **LP** for five seconds or longer. If pressed for five seconds or more, a buzzer sound is heard, and the chair position at that point is memorized as the set position.

[Reference] Automatic operation setting [page 143]

### WARNING

Before moving the chair, confirm that no human body part, limb, or obstacle is obstructing the chair.

### 5-6 Operating the headrest (manual type)

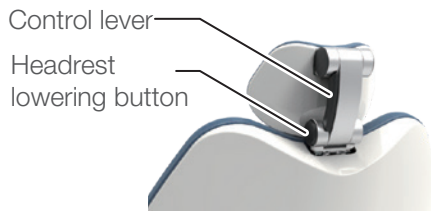

Angle and up/down of headrest

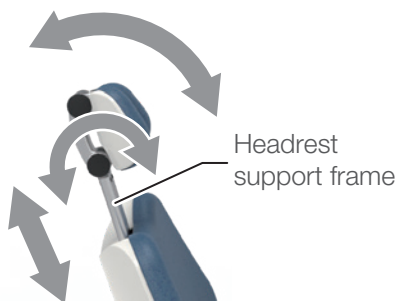

#### Adjustment of the headrest

The headrest (manual type) is capable of flexibly adjusting the inclination of the patient's head for treatment in the upper/lower jaw. It is also possible to manually extend/fold the headrest in accordance with the patient's height.

#### Angle adjustment of the headrest

- 1, Insert the operator's hand beneath the headrest to support the patient's head.
- 2, Press in the control lever with the other hand to make the headrest movable.
- 3, Adjust the headrest to an angle that matches the required treatment, and release the control lever to lock the headrest.

#### Up/down adjustment of the headrest

- 1, To raise the headrest, pull the headrest up slowly while holding it.
- 2, To lower the headrest, apply the operator's hand to the headrest, and pull it down slowly while pressing the headrest lowering button.

Do not apply excessive load or impact to the headrest while it is extended. Do not hit the headrest from above. Otherwise, failure may result.

### WARNING

If the backrest is to be moved while the headrest is extended, confirm that there is no object obstructing or coming into contact with the chair. Otherwise, damage or injury may result.

When operating the headrest, be careful not to get the operator's hand or finger caught around the control lever or between the headrest and the backrest.

When adjusting the angle or up/down, be sure to apply the operator's hand to the headrest and support the patient's head. Otherwise, an accident or injury may result.

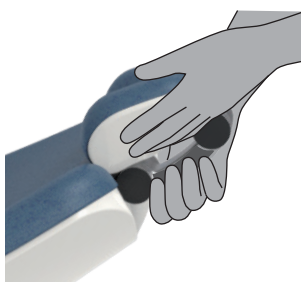

## 5-7 Operating the headrest (electrohydraulic type)

For operation with the manual operation switch, press the chair/headrest switch  to switch over to the headrest function (the light is turned on).

Headrest (electrohydraulic)



Stick switch for headrest (electrohydraulic)





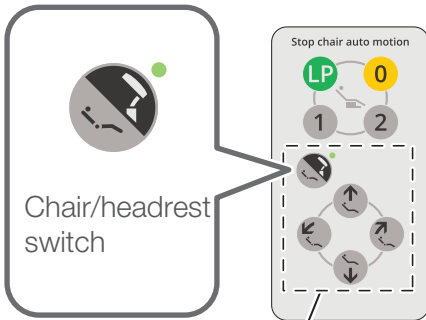











The position and/or availability of the stick switch may differ according to the specification selected.

Doctor control panel  
Membrane switch



Chair/headrest switch

Switch for manual operation

Stick switch		Operation panel switch (  lamp is turned on)	Operation
Pushing direction	Label indication		
			Raise 
			Lower 
			Raise 
			Recline 

\* The headrest is operated while the stick switch is pushed down or the switch is pressed.

Do not apply excessive load or impact to the headrest while it is extended. Do not hit the headrest from above. Otherwise, failure may result.

### WARNING

Before moving the headrest, confirm that the patient's head is placed in the correct position. Operator must not take their eyes off the patient during movement.

Do not use the unit at an angle that causes discomfort to the patient.

When moving the headrest, confirm that there is no object obstructing. Be very careful not to get an object or human body part caught between the headrest and the backrest.

[Reference] Precautions when a patient is seated [page 19]

### 5-8 Turning the armrest

If the armrest hinders entry/exit or treatment, it may be turned backward.

Only the right armrest can be turned.

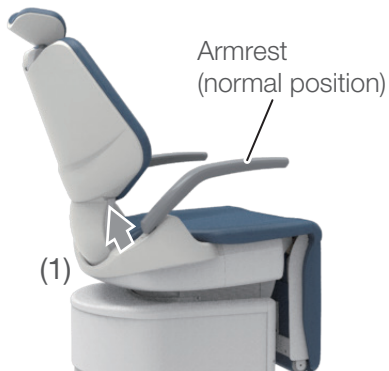

(1) Pull the root of the armrest (back side) diagonally upward.

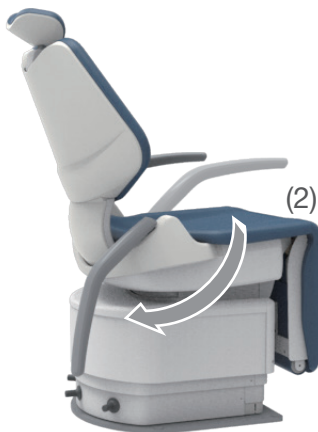

(2) Turn the armrest backward while holding it up.



(3) To return the armrest to the original position, turn it forward in the same procedure.

The armrest is locked when it comes to the normal position.

### CAUTION

When turning the armrest, confirm that there is no obstruction. Operator must be careful not to get their hand or finger caught.

Do not move the chair while the armrest has been turned backward. Return the armrest to the normal position before moving the chair.

## 5-9 Relationship among the angles of the backrest, legrest and footrest

“Up/down” of the legrest and “Extend/fold” of the footrest only function during automatic movement.

The angle of the legrest is automatically determined based on the angle of the backrest in the automatic movement setting.

In the case of headrest (electrohydraulic), the extending width of the footrest is automatically determined based on the headrest up/down position during automatic movement.

In the case of headrest (manual type), the extending width of the footrest is automatically determined based on the backrest angle in the automatic movement setting.

### Electrohydraulic type

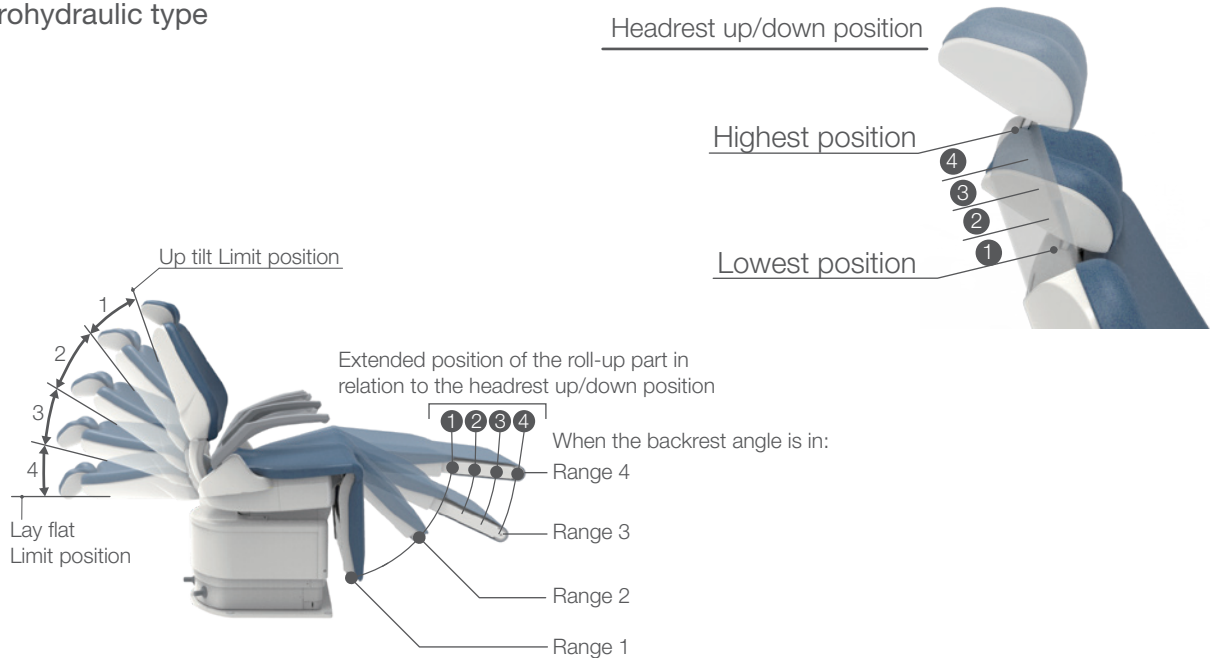



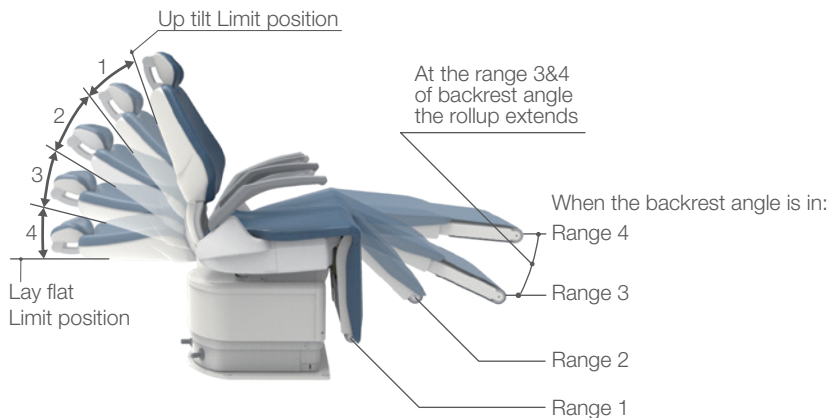

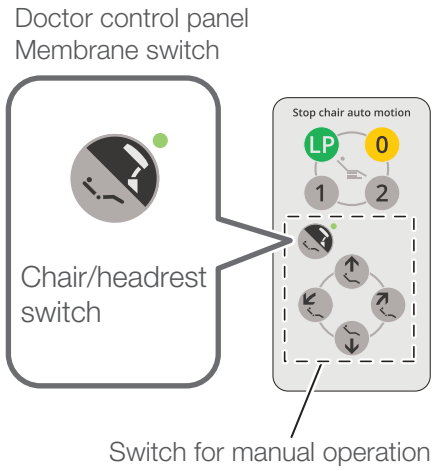
### Manual type



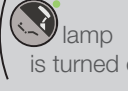

## 5-10 Operating the legrest

By holding down the chair/headrest switch  for approx. one second or more, the unit is switched into the legrest control mode (the light is flashing), and the legrest becomes controllable.

Operation panel switch  lamp is turned on	Operation
	 The legrest is raised
	 The legrest is lowered

\* The legrest can be moved while the switch is pressed down.

### Headrest (manual type)

The extending width of the footrest is automatically determined based on the legrest angle.

### Headrest (electrohydraulic type)

The extending width of the footrest is determined based on the legrest angle and the headrest height.

To cancel the legrest control mode, press the chair/headrest switch  again.

[Touch panel]



### Notification of the legrest control mode

When the chair/headrest switch  is pressed after powering on the unit, a popup screen notifying the legrest control mode is displayed only once.

Press the  switch to close the popup.



Before raising/lowering the legrest, confirm that no human body part, limb, or obstacle is obstructing the chair.



## 5-11 Operating the doctor table

### Base mount

Moving the doctor table forward/backward and right/left  
Hold the handle and slowly move the doctor table.



### WARNING

Do not apply a load exceeding 3 kg to the doctor table.  
Otherwise, damage or injury may result.

### Height adjustment of the doctor table

The height of the doctor table can be adjusted in the range as shown in the left figure.

To change the height, release the brake first by pressing the balance arm brake release switch at the center of the handle. Then, move the doctor table upward/downward.



Moving the doctor table upward/downward without releasing the brake may cause damage to the product.  
Be sure to release the brake first by pressing the brake release switch. Then, move the doctor table upward/downward.

### Cart

The height of the doctor table can be adjusted in the range as shown in the left figure.

To change the height, loosen the lock knob and pull up/down the doctor table.

After changing the height to the desired position, tighten the lock knob securely.

Loosen the lock knob → turn it counterclockwise

Tighten the lock knob → turn it clockwise

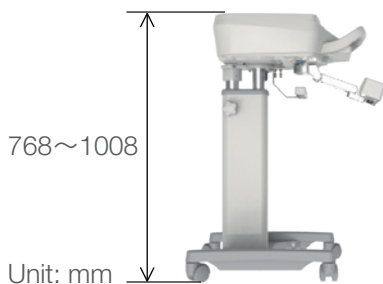

Moving the doctor table upward/downward without loosening the lock knob may cause damage to the product.  
Be sure to loosen the lock knob first, then move the doctor table upward/downward.



### 5-12 Control of the assistant tray

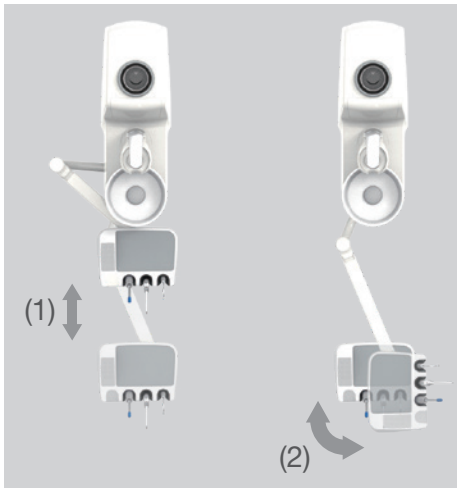

**(1) Moving the assistant tray forward/backward**  
Hold the assistant tray and slowly move it forward/backward.

**(2) Turning the assistant tray**  
Hold the assistant tray and slowly turn it.  
It is possible to turn the tray only.

When moving the assistant tray forward/backward, make sure there is nothing on the assistant tray.

 **WARNING**

Do not apply a load exceeding 1.5 kg to the assistant tray.  
Otherwise, damage or injury may result.

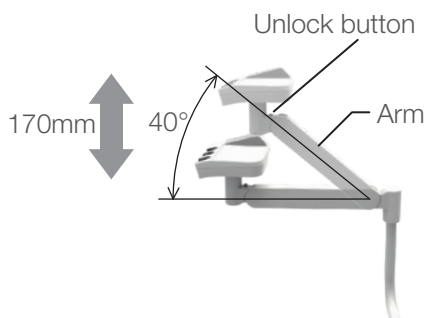

### Height adjustment of the assistant tray

The height of the tray can be adjusted by stopping the arm angle in the range from 0 to 40 degrees (see the figure on the left). To change the height, move the tray while holding the arm part.

#### 1) To raise the height

Hold the tray when moving it upward.

#### 2) To lower the height

First move the arm upward while pressing the unlock button, and subsequently move it downward. Move the tray to the desired height, and release the unlock button.

When adjusting the height of the assistant tray, make sure there is nothing on the assistant tray.

To lower the height, be sure to press down the unlock button during adjustment.

Lowering the height without pressing the unlock button may cause damage to the product.



### WARNING

Do not apply a load exceeding 1.5 kg to the assistant tray. Otherwise, damage or injury may result.

## 5-13 Handpiece

When a handpiece other than the syringe is picked up from the instrument holder, the operation screen for the handpiece is displayed on the touch panel. Subsequently, operate the foot controller to move the unit.



[Reference]	Micromotor	[pages 108 to 121]
	Ultrasonic scaler	[pages 122 to 124]
	Air Turbine /motor	[pages 125 to 127]
	Vacuum handpiece	[pages 135]
	Saliva ejector handpiece	[pages 135]
	Foot controller (wired/wireless)	[pages 129]

(Example of display) Micromotor MX2

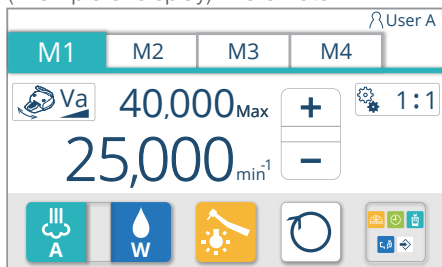

	Syringe	
Instrument	Handpiece	Micromotor
		Ultrasonic scaler
		Air turbine
		Air motor
		Vacuum handpiece
		Saliva ejector handpiece

When the handpiece is returned to the instrument holder, the home screen is displayed.

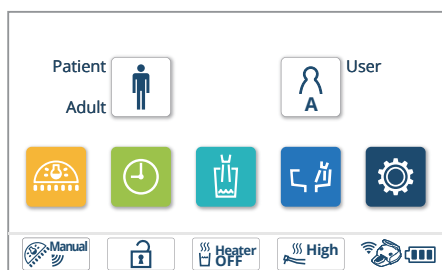

### Handpiece priority function (first priority)

Only the handpiece that is picked up first is operable.

If two or more handpieces are picked up from the instrument holder, and if the handpiece picked up first is returned to the holder, a message [C12: HP first priority] is displayed.

This message disappears if all handpieces are returned to the instrument holder.



## 5-14 Doctor operation panel

### Touch panel (home screen)

The overview of indications and switches on the touch panel is as follows.

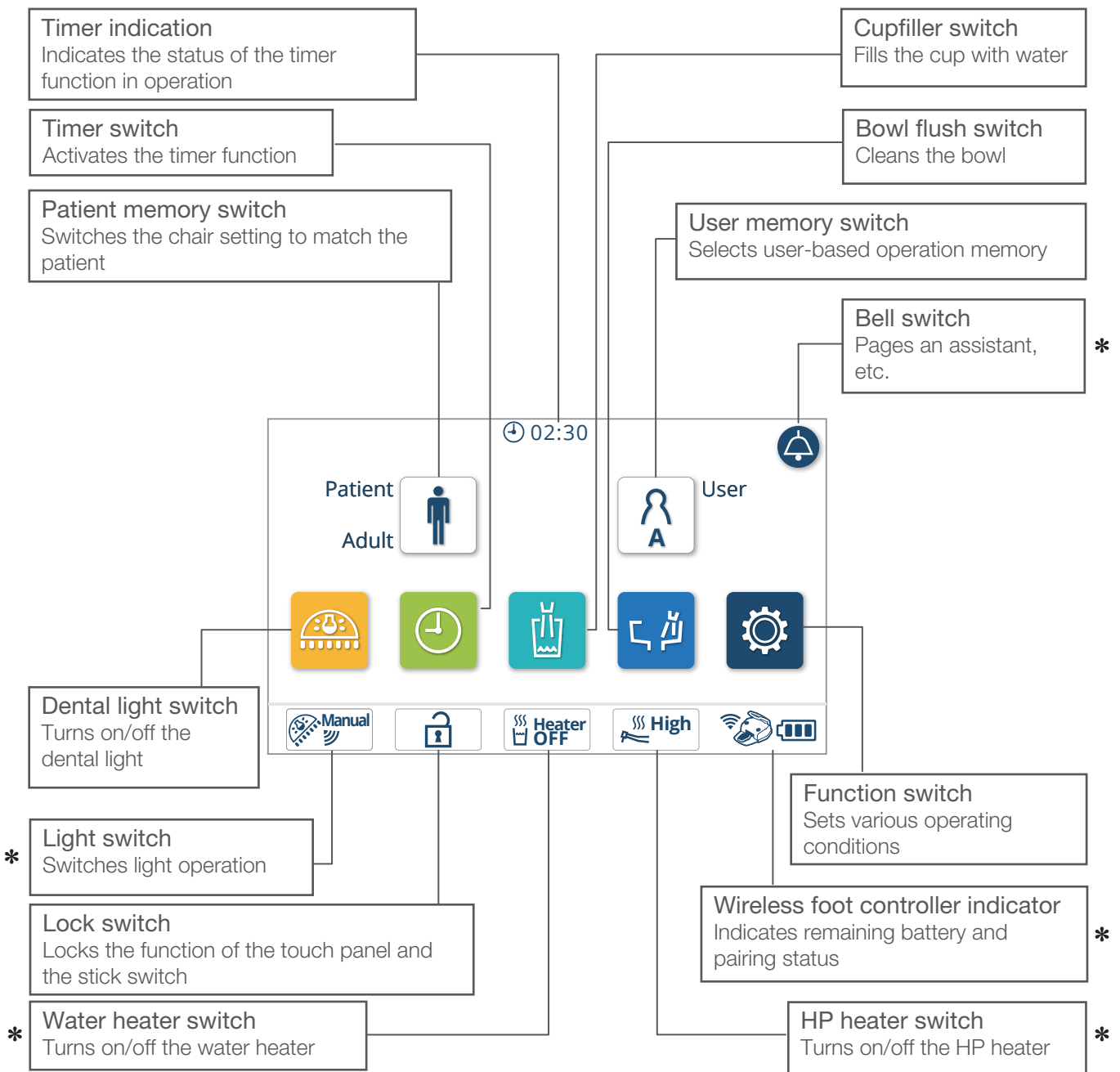

\* Not indicated if the function is not installed

## Touch panel (handpiece screen)

The overview of indications and switches on the touch panel is as follows.

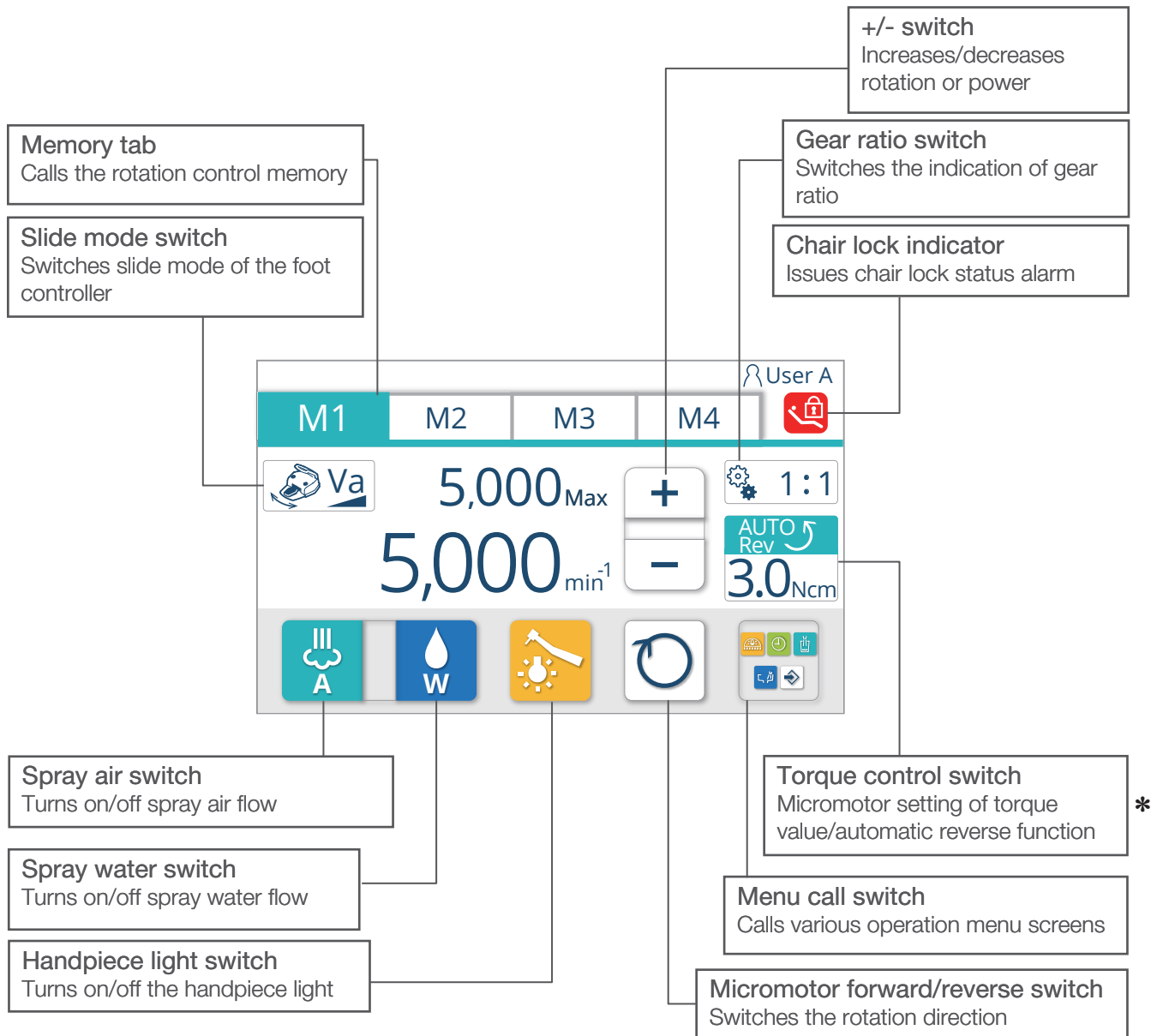

\* Not indicated if the function is not installed

## Membrane switch

The overview of indications and switches on the operation panel is as follows.

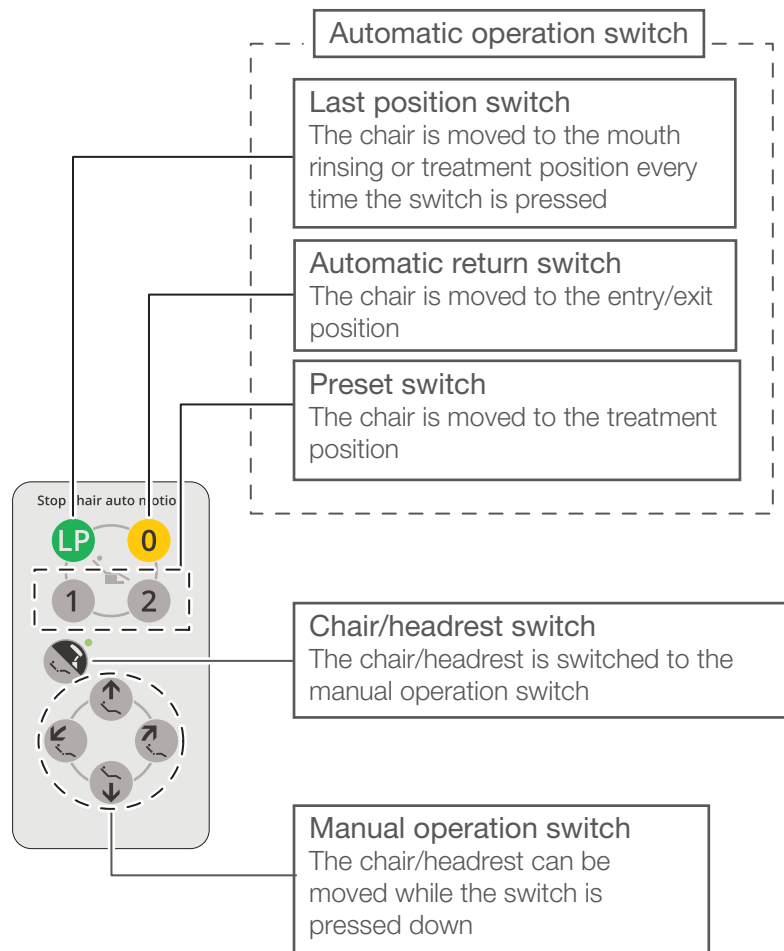
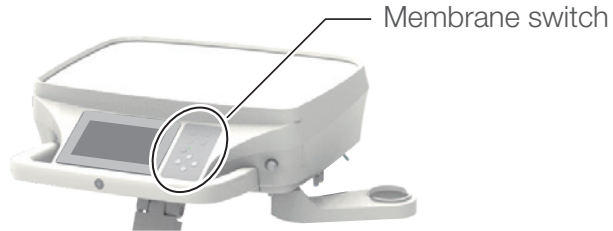



### Last position switch

When pressed in the treatment position, the chair is moved to the mouth rinsing position.

When the switch is pressed again, the chair is returned to the treatment position prior to mouth rinsing.



### Automatic return switch

The chair is moved to the entry/exit position.

\* In the case of headrest (electrohydraulic), by pushing this switch again after the chair comes to the complete stop, the headrest is housed.



### Preset switch

When **1** is pressed, the chair is moved to treatment position 1.



When **2** is pressed, the chair is moved to treatment position 2.

Do not hold down the preset switch, automatic return switch, or last position switch for five seconds or longer.

If pressed for five seconds or more, a buzzer sound is heard, and the chair position at that point is memorized as the set position.

[Reference] Automatic operation setting [page 143]



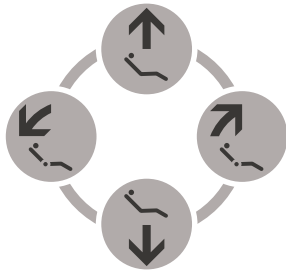

## Manual operation switch

Manually operates “Raise/lower” and “Raise/recline” of the chair/headrest.

Switch	Operation
	The chair is raised / The headrest is raised
	The chair is lowered / The headrest is lowered
	The backrest is reclined / The headrest is reclined
	The backrest is raised / The headrest is raised

\*The chair/headrest can be moved while the switch is pressed down



When the headrest function is selected, the lamp is turned on

## Chair/headrest switch

Switches the chair/headrest functions to the manual operation switch. When the headrest function is selected, the lamp is turned on.

## WARNING

Before moving the chair, confirm that no human body part, limb, or obstacle is obstructing the chair. Take particular precautions for the movement and behavior of children during operation.

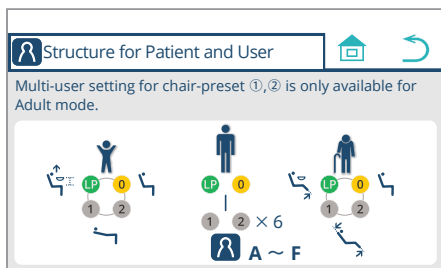
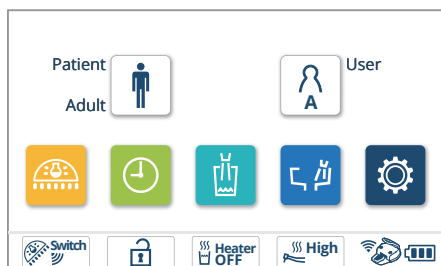

## Structure of user/patient memories

Up to six user memories (A to F) and up to three patient memories (Adult, Child and Elderly) can be set.

### [Adult]

#### :Adult mode



A recommended mode for an adult patient of a standard figure; In addition to the automatic return switch **0** and the last position switch **LP**, the preset switches **1** **2** can be set for up to six user memories (A to F).

### [Child]

#### :Child mode



A recommended mode for a child patient or a patient of a small figure; The automatic return switch **0**, the last position switch **LP**, and the preset switches **1** **2** can be set respectively.

In the case of a pedestal type, the height of the chair at mouth rinsing position can be set.

A treatment position without extending the legrest can be set, and the position around the legrest can be achieved.

### [Elderly]

#### :Elderly mode



A recommended mode for an elderly patient or a patient who requires special considerations;

The automatic return switch **0**, the last position switch **LP**, and the preset switches **1** **2** can be set respectively.

The angles of the backrest and legrest can be limited, and other settings are possible.

## Calling the Structure of user/patient memories

1. Press the user memory switch .  
The "Selection of user" screen is displayed.

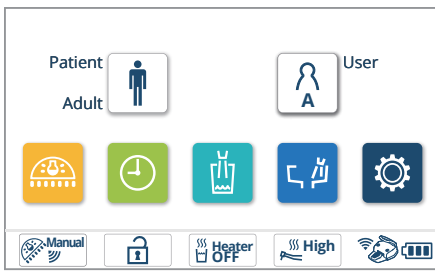

2. On the "Selection of user" screen, press the  switch.  
The "Structure for Patient and User" screen is displayed.

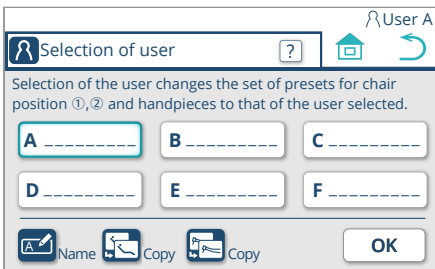

Press the  switch to return from the present screen to the home screen.

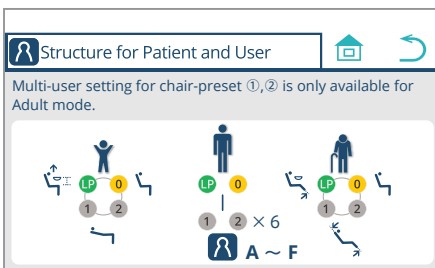

Press the  switch to return from the present screen to the previous screen.

## Patient memory selection switch

The treatment position setting of the chair can be switched in accordance with the patient to be treated.

Every time the switch is pressed, the mode is toggled "Adult" > "Elderly" > "Child".

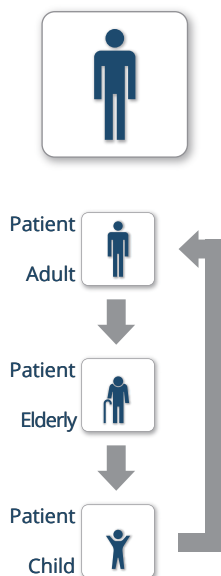



## User memory switch

The preset chair position for each user and the initial settings for handpieces upon powering on can be memorized, and selected when necessary.

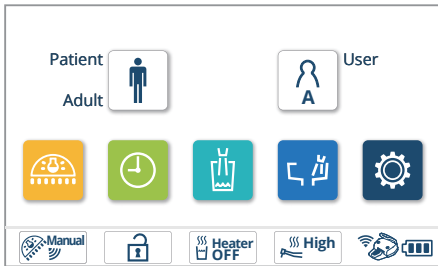

1. Press the user memory switch . The “Selection of user” screen is displayed.

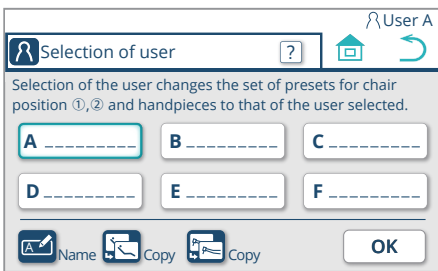

2. On the “Selection of user” screen, press the memory switch for the user to be called for selection.

(In this case, user is selected.)

Press to call the settings for the newly selected user , and return to the home screen.

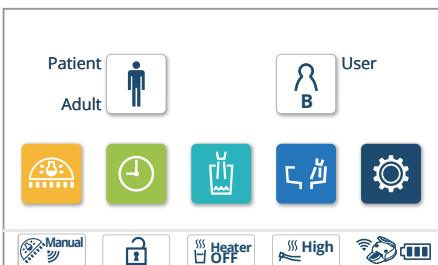
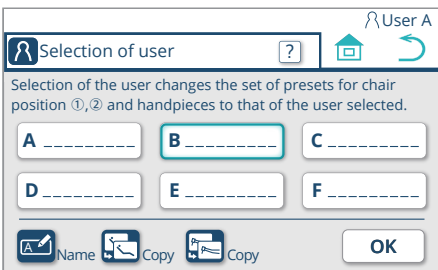

## Name registration

A name can be registered for each user memory.

1. Press the user memory switch . The “Selection of user” screen is displayed.

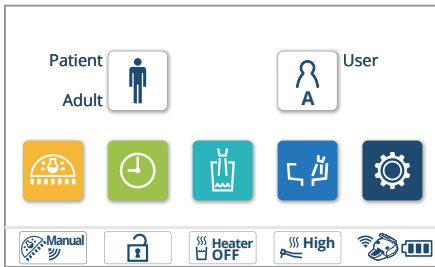

2. On the “Selection of user” screen, press the switch for the user memory for selection and name registration. (In this example, User memory A is selected.)

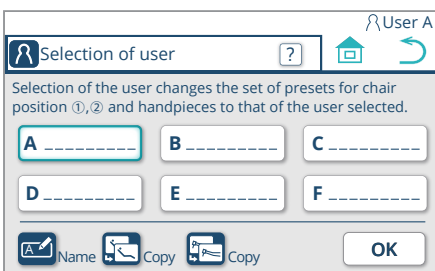

Press the name registration switch  to view the “Registration of name” screen for the selected user .

3. Enter the name using the keyboard.

Press **OK** to view the “Selection of user” screen.



User name can be entered in alphabetical or numeric format up to nine digits.

When switching alphanumeric input, press the alphanumeric switch .

Press the backspace switch  to delete the previous (left) character at the cursor position during the character input.

In this example, the name “BELMONT” has been entered. The registered name is indicated for the User memory A box and displayed at the top right.

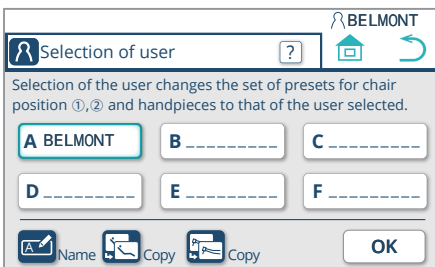

\* The registered name is indicated to the right of the user memory switch on the home screen.

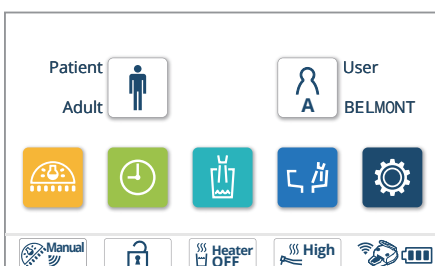

## Copying the chair preset

The settings for the chair preset switches 1, 2 in the Adult mode can be copied to another user memory.

1. On the “Selection of user” screen, press the chair copy switch .

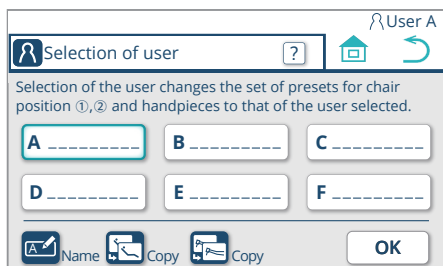

2. Select the “Copied from” user from [A] to [F].

The “Copied from” switch indication is changed to show the selected user.

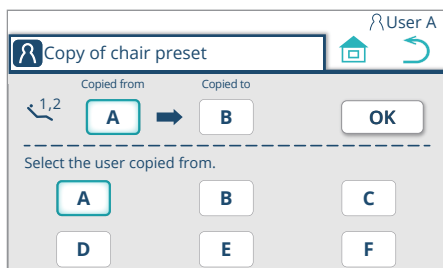

3. Press the “Copied to” switch and select the “Copied to” user from [A] to [F].

The “Copied to” switch indication is changed to show the selected user.

Press the  switch to view the popup screen for confirmation.

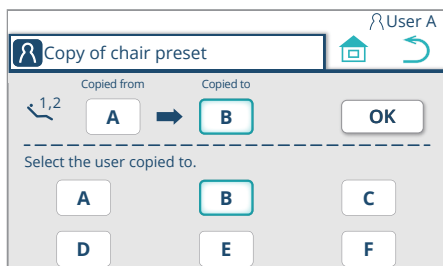

4. To confirm, press .

The copying is completed, and the “Selection of user” screen is displayed.

Press  to return to the previous screen without copying.

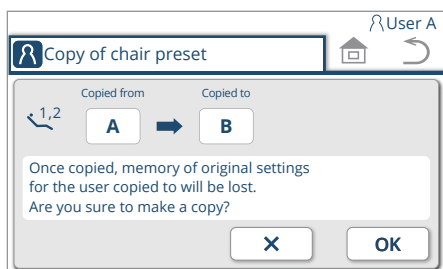

## Copying the handpiece setting

The initial setting of a handpiece upon powering on can be copied to another user memory.

1. On the “Selection of user” screen, press the “Copy of handpiece setting” switch  .

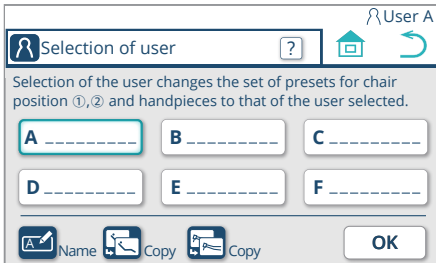

2. Select the “Copied from” user from [A] to [F].

The “Copied from” switch indication is changed to show the selected user.

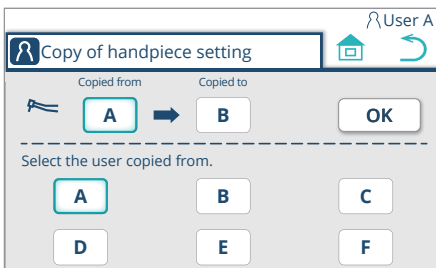

3. Press the “Copied to” switch and select the “Copied to” user from [A] to [F].

The “Copied to” switch indication is changed to show the selected user.

Press  to view the popup screen for confirmation.

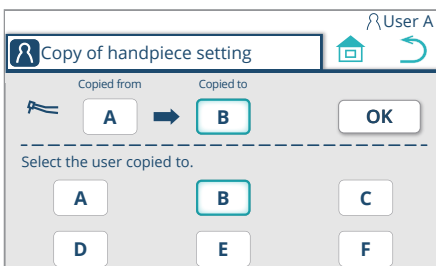

4. To confirm, press  .

The copying is completed, and the “Selection of user” screen is displayed.

Press  to return to the previous screen without copying.

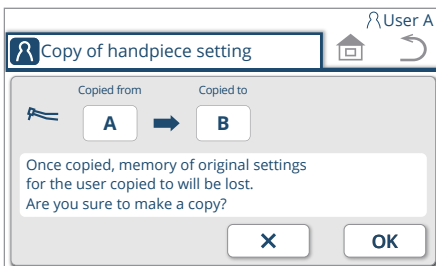



### Dental light switch

Turns on/off the dental light;

On/off is toggled;

\* Pressing and holding the switch while the light is on for 2 seconds or more changes the mode into Composite Safe.

\* The ceiling light and the track light are not operable.



### Timer switch

For the use and setting of the timer

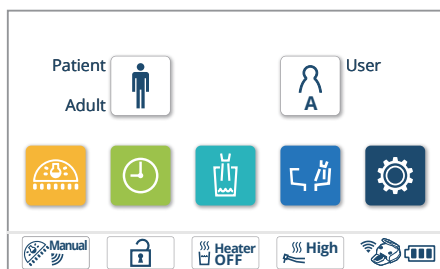

### <How to use the timer>

Time for the timer can be selected from four memories.

1. Press the timer switch 

The "Timer" screen is displayed.



2. Select a memory (in this example, "Timer D: 5 minutes" is selected)



The operation/setting screen for Timer D is displayed.

Press the home switch  to cancel the operation and return to the home screen.

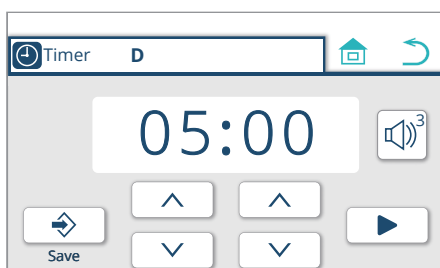
To return to the previous operation screen, use the return switch .



### 3. Change the timer setting

Every time the increase/decrease switch  /  is pressed, time for the timer can be increased/decreased by one minute for the minute digit, and by ten seconds for the second digit.

: increase the set time

: decrease the set time

Press the store switch  to save the changed setting into the memory.



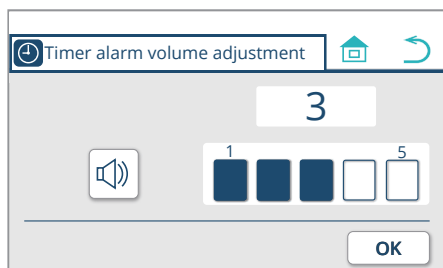



#### 4. Change the alarm volume for the timer

When the alarm volume adjustment switch  is pressed, the “Timer alarm volume adjustment” screen is displayed.

Press the touch bar graph  to adjust the alarm volume in five levels.

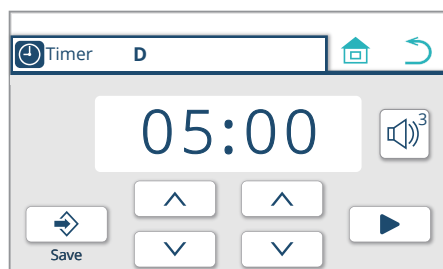

Press the alarm sound switch  to mute or de-mute the alarm. Once adjustment is completed, press the  switch to return to the previous screen.

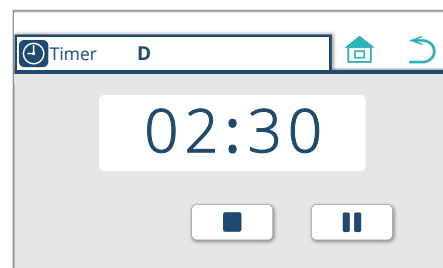

#### 5. Press the start to start the countdown of the timer

The subtraction timer is started.



Press the pause  to pause the timer operation. To restart the timer, press the start .

Press the stop  to cancel the timer operation, and return to the screen in 3.

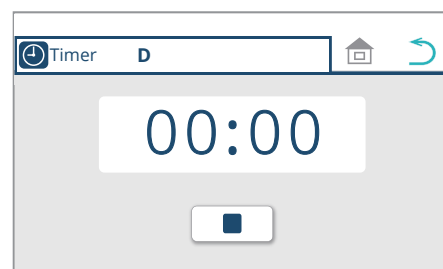

#### 6. Once the timer countdown is completed, an alarm sounds

Alarm sounds for the specified time, then it stops automatically.

Press the stop  to stop the alarm sound, and return to the home screen.

\* If the timer operation is performed on the handpiece screen while the handpiece is picked up, the display returns to the relevant handpiece screen.

# 5 Operation

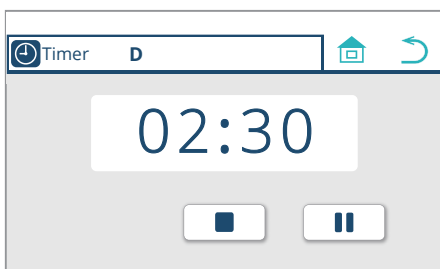
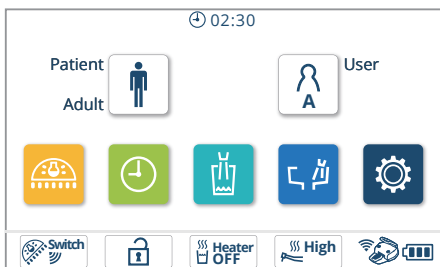
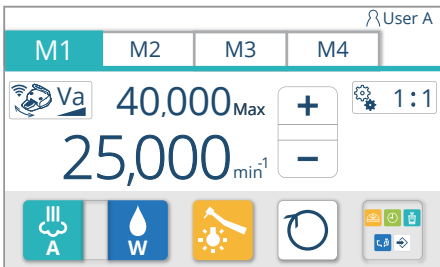
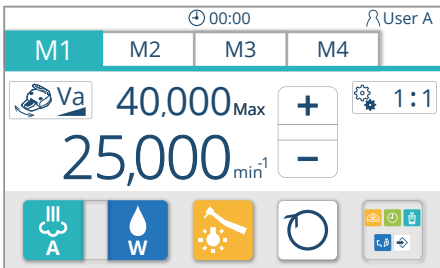
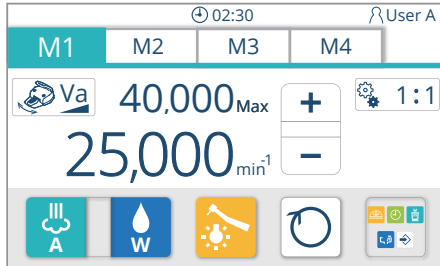
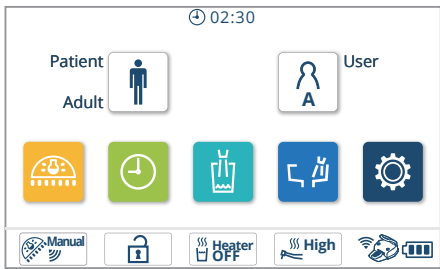

## 7. Returning to the home screen during timer operation

Press the home switch  while the timer is operating to return to the home screen. The timer operation status is displayed at the top of the screen.

When the timer countdown is completed on the home screen, the screen in 6 is displayed.

\* With the handpiece being picked up, even if the timer switch is

pressed after pressing the menu call switch , the timer will not

start, and the display returns to the handpiece screen.

Once the countdown of the timer is completed with the handpiece being picked up, timer switch  appears on the screen.

If the timer switch  is pressed, handpiece display appears on the screen.

If the handpiece is returned without pressing the timer switch , the display shown in 6 appears.

## 8. Changing the mode into timer display

Press the timer switch  during the countdown process to show the timer display on the screen as shown in 5.



### Cupfiller switch

This is a switch for filling the cup, installed separately from the sensor cupfiller.

When this switch is pressed, water is released from the cupfiller nozzle. Water is also released from the bowl flush nozzle to flush the cuspidor bowl.

Cupfiller operates by timer for a specified time period.

To stop cupfiller before the specified time is elapsed, press this switch again.

Before using cupfiller, put a cup on the cupfiller base. Otherwise, the wall and the chair may be spattered with water. Cupfiller operates for a specified time period, regardless of the water level in the cup. Be careful not to overflow the cup.



### Bowl flush switch

Water is released from the bowl flush nozzle to flush the cuspidor bowl (approx. six seconds).

Hold down the switch for two seconds or longer for continuous flushing.

Press this switch again to stop flushing.



### Function switch

For setting various operating conditions [pages 145-186]

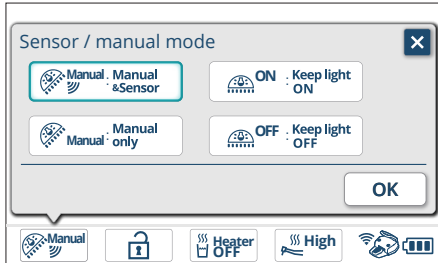









## Light switch

Call the “Sensor/Manual switch mode” screen to switch the operation mode for the dental light.

Select an operation mode and press **OK** to change the setting.

Press **X** to cancel the change and exit.

Indication	Mode	Condition
	Sensor/ switch mode	The light can be turned on/off with the touchless switch of the dental light and with the dental light switch  .
	Switch mode	The light can be turned on/off with the dental light switch  * The light cannot be turned on/off with the touchless switch of the dental light
	ON mode	The dental light is continuously turned on at the maximum illuminance. * The light cannot be turned on/off with the touchless switch of the dental light and with the dental light switch  .
	OFF mode	The dental light is continuously turned off * The light cannot be turned on/off with the touchless switch of the dental light and with the dental light switch  .
(No indication)	Not installed	The dental light is not installed in the product.

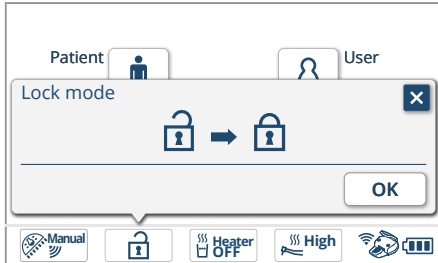

## Lock switch

To clean the operation panel or to prevent mischief by child patients, the touch panel, membrane switch or the stick can be locked.

Call the “Lock mode” screen and press **OK** to lock the operation.

During locking, the locking message screen is displayed on the touch panel.

To cancel the operation lock, press and hold the chair/headrest switch  for approx. one second or more.

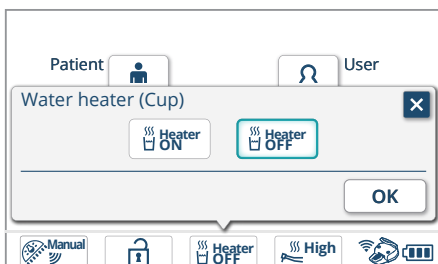
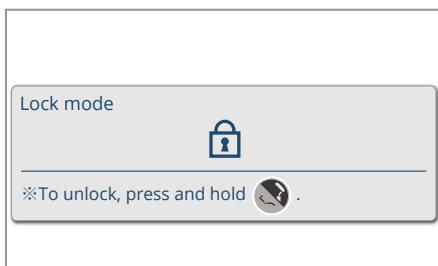

## Water heater switch

Call the “Water heater (Cup)” screen to set cupfiller water to warm water.

Select the heater mode (ON/OFF) and press **OK** to change the setting.

Press **X** to cancel the change and exit.

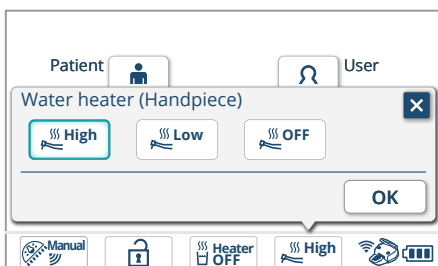

## HP heater switch

Call the “Water heater (Handpiece)” screen to set water released from the handpiece to warm water, and to set the temperature of water (two temperatures).



Select the heater mode (High, Low, OFF) and press **OK** to change the setting.

Press **X** to cancel the change and exit.



### Wireless foot controller indication

Indicates the remaining battery and pairing status of the wireless foot controller.

As the battery level declines, the indication changes from  to . After a warning popup screen is displayed, the indication is changed to .

Once the popup is displayed, promptly replace the battery with a new one. [Reference] How to replace batteries [page 131]

Press  to close the popup.

If the wireless foot controller has not been paired,



is displayed, and the foot controller is not usable.

If it is not usable, turn off the main switch and reboot the unit, then perform pairing the wireless foot controller.



### Bell switch

An assistant, etc. can be paged by using an externally connected device.

Air ON / Water ON (Spray ON)

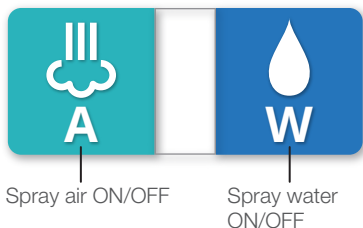

Air OFF / Water ON



Air ON / Water OFF

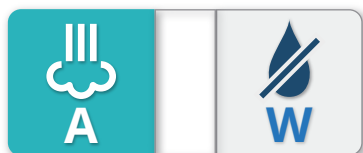

Air OFF / Water OFF (Spray OFF)



Light on



Light off



## Spray switch

Turns ON/OFF handpiece spray (water and air).

Pick up a handpiece and press the switch to toggle between ON/OFF of A (Air) and W (Water).

In the case of ultrasonic scaler, the W (Water) is turned on regardless of the spray mode. OFF cannot be selected.

In the case of micromotor / air turbine / air motor, two modes or four modes can be selected depending on the spray mode setting. When set to two modes, Spray ON/OFF is toggled. When set to four modes, ON/OFF can be respectively toggled for Air and Water.

[Reference] Spray mode setting [page 174]

## Handpiece light switch

Turns on/off the handpiece light.

The light is toggled between on and off.

[Reference] Setting the light activation timing [page 175]

Forward rotation (clockwise)



Reverse rotation (counterclockwise)



Reciprocal mode (unswitchable)



## Micromotor forward/reverse switch

Switches the rotation direction of the micromotor.

Forward rotation (clockwise) and reverse rotation (counterclockwise) is toggled.

Rotation is set to forward immediately after powering on.

\* The rotation direction cannot be switched while the micromotor is being rotated.

## Menu call switch

Calls menu screens for performing the following operations while a handpiece is picked up.

Dental light on/off

[Reference] Dental light switch [page 88]

Use and setting of timer

[Reference] Timer switch [pages 88-90]

Cupfiller

[Reference] Cupfiller switch [page 91]

Cuspidor bowl flush

[Reference] Bowl flush switch [page 91]

Memory of handpiece operating condition setting

[Reference] Store switch [page 96]

## Store switch

This switch is displayed when the rotation, spray condition and other settings have been changed from the memory on the handpiece screen. Press the switch to overwrite the called memory (M1 to M4) with the changed setting.

## Slide mode switch

Switches the slide mode (Va/Fix) of the foot controller.

[Reference] Micromotor [page 108]



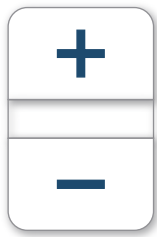

### +/- switch

In the case of micromotor, the maximum rotation value is increased/decreased.

[Reference] Micromotor [page 109]



### Gear ratio switch

The indication can be switched to rotation that matches the contra angle gear ratio of the micromotor.

[Reference] Micromotor [page 111]

Automatic reverse function and  
Torque value 3.5 Ncm



### Torque control switch

The condition of torque value and automatic reverse function can be set in the case of micromotor that accepts setting in low-speed rotation range.

[Reference] Micromotor [page 113,114,116 to 119]

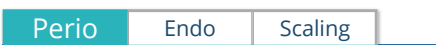

### Memory tab

The preset memories of handpiece settings can be called and switched.

[References] Micromotor [page 108]

Ultrasonic scaler [page 122]

Turbine [page 125]

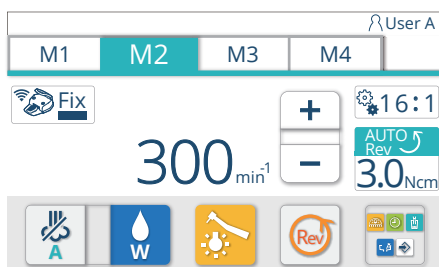
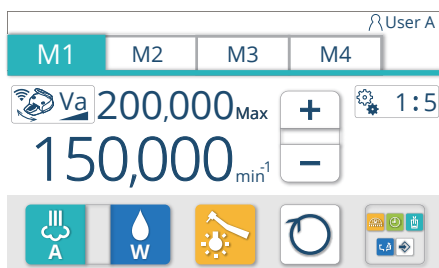

## 5-15 Assistant operation panel

### Assistant Unit type

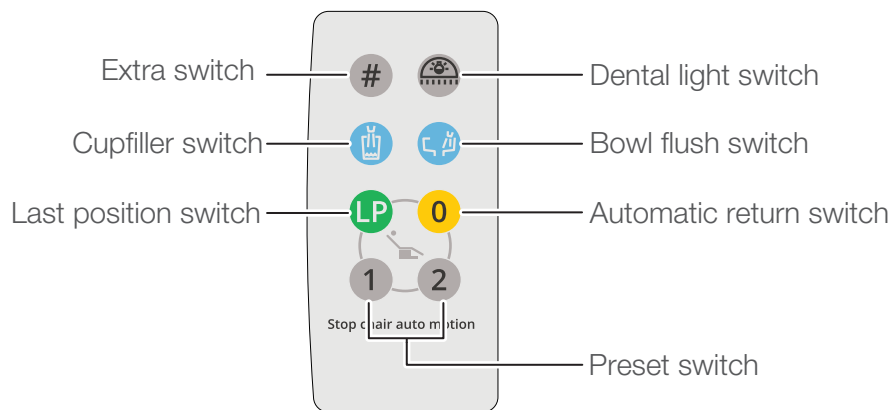

### Dental light switch

Turns on/off the dental light;  
On/off is toggled;

\* Pressing and holding the switch while the light is on for 2 seconds or more changes the mode into Composite Safe.

\* The ceiling light and the track light are not operable.



### Extra switch

When this switch is held down for two seconds or longer, the the touchless switch of the dental light is invalidated.

The LED indicator in the cuspidor unit is turned on in pink.

When this switch is held down for two seconds or longer, the dental light sensor is validated.

The LED indicator in the cuspidor unit is returned to the original color.



### Cupfiller switch

This is a switch for filling the cup, installed separately from the sensor cupfiller.

When this switch is pressed, water is released from the cupfiller nozzle. Water is also released from the bowl flush nozzle to flush the cuspidor bowl.

Cupfiller operates by timer for a specified time period.

To stop cupfiller before the specified time is elapsed, press this switch again.

Before using cupfiller, put a cup on the cupfiller base. Otherwise, the wall and the chair may be splattered with water. Cupfiller operates for a specified time period, regardless of water level in the cup. Be careful not to overflow the cup.



### Bowl flush switch

Water is released from the bowl flush nozzle to flush the cuspidor bowl (approx. six seconds).

- Hold down the switch for two seconds or longer for continuous flushing.
- Press this switch again to stop flushing.



### Last position switch

The chair is moved to the gargle position when this switch is pressed in the procedure position.

Press it again to return the chair to the procedure position prior to gargling.



### Automatic return switch

The chair is moved to the entry/exit position.

\* In the case of headrest (electrohydraulic), by pushing this switch again after the chair comes to a complete stop, the headrest is housed.



### Preset switch

When ① is pressed, the chair is moved to treatment position 1.

When ② is pressed, the chair is moved to treatment position 2.



Do not hold down the preset switch, automatic return switch, or last position switch for five seconds or longer. If pressed for five seconds or more, a buzzer sound is heard, and the chair position at that point is memorized as the set position.

[Reference] Automatic operation setting [page 143]



Before moving the chair, confirm that no human body part, limb, or obstacle is obstructing the chair.

Take particular precautions for the movement and behavior of children during operation.

## Vac Pac Unit type

Assistant control panel



Last position switch

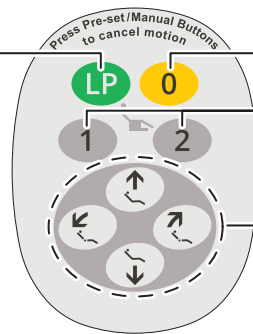

Automatic return switch

Preset switch

Manual operation switch



### Last position switch

The chair is moved to the gargle position when this switch is pressed in the procedure position.

Press it again to return the chair to the procedure position prior to gargling.



### Automatic return switch

The chair is moved to the entry/exit position.

\* In the case of headrest (electrohydraulic), by pushing this switch again after the chair comes to a complete stop, the headrest is housed.



### Preset switch

When **1** is pressed, the chair is moved to treatment position 1.

When **2** is pressed, the chair is moved to treatment position 2.



Do not hold down the preset switch, automatic return switch, or last position switch for five seconds or longer. If pressed for five seconds or more, a buzzer sound is heard, and the chair position at that point is memorized as the set position.

[Reference] Automatic operation setting [page 143]

## WARNING

Before moving the chair, confirm that no human body part, limb, or obstacle is obstructing the chair.

Take particular precautions for the movement and behavior of children during operation.

### Manual operation switch

Manually operates "Raise/lower" and "Raise/recline" of the chair.

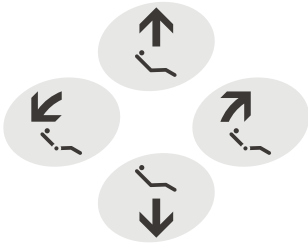

Switch	Operation
	The chair is raised
	The chair is lowered
	The backrest is reclined
	The backrest is raised

\*The chair/headrest can be moved while the switch is pressed down

### WARNING

Before moving the chair, confirm that no human body part, limb, or obstacle is obstructing the chair. Take particular precautions for the movement and behavior of children during operation.

## 5-16 Cancellation function

To stop the chair movement started by a switch for automatic operation (preset switch, automatic return switch, last position switch, or stick switch for automatic operation), perform one of the following operations.



### Stick switch

Operate one of the stick switches (indicated with ○).



### Foot controller

Step on the pedal.

Assistant operation panel  
(Assistant Unit type)

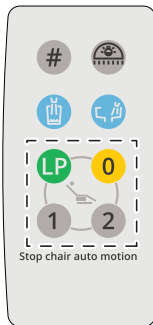

### Assistant operation panel

Press one of the switches in the [ ] frame.

Assistant operation panel  
(Vac Pac Unit type)

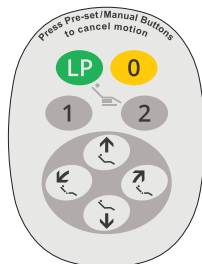

Press one of the switches.

Doctor control panel  
Membrane switch

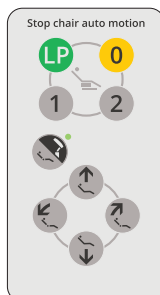

### Membrane switch

Press one of the switches.

## 5-17 Lock function

### 5-17-1 Chair lock function

When the lock function is activated, indications as listed below are displayed on the touch panel. (When force is applied to the rear link cover, the lock function is activated.)

Home screen

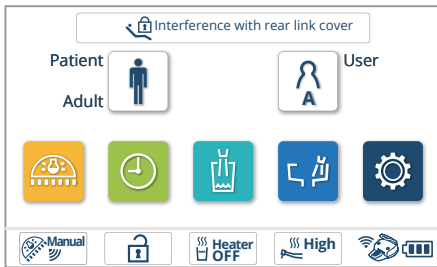

Home screen :

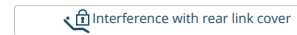

Handpiece screen

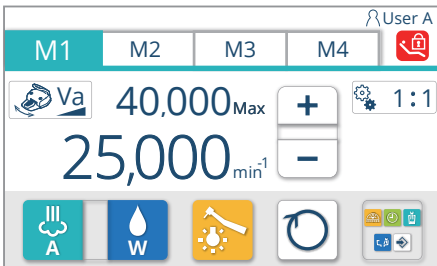

Handpiece screen :



When the lock function is activated, the chair movement is stopped, and a popup is opened to notify the abnormality. Check the popup and promptly eliminate the abnormality.



Eliminate the abnormality or press **X** to close the popup.

The functions that become locked and the unlocking steps are as follows.

[Reference] [pages 104 to 106]

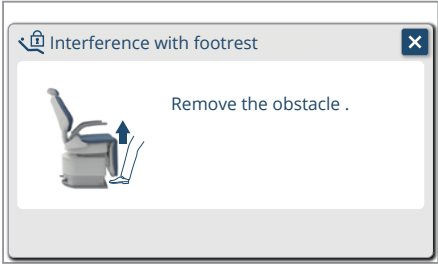
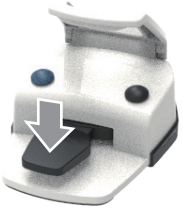

The LED indicator in the cuspidor unit is turned on in orange.

# 5 Operation



<p style="text-align: center;">Condition 1</p> <p>If force is applied to the footrest in the direction indicated with an arrow during the automatic movement or manual lowering of the chair, the lock function is activated, and the chair is raised for approx. one second and stopped.</p> <p>* The lock function is activated when the legrest angle is less than 45 degrees.</p> 	<p style="text-align: center;">Touch panel indication</p>  <p style="text-align: center;">How to unlock</p> <p>Remove the obstacle that has caused emergency stop, confirm safety, and operate the chair.</p> <p style="text-align: center;">Locked functions</p> <p>Automatic operations and manual operations of the chair (lowering/raising)</p>
<p style="text-align: center;">Condition 2</p> <p>When the foot controller pedal is stepped on during the automatic operation of the chair</p> 	<p style="text-align: center;">Touch panel indication</p>  <p style="text-align: center;">How to unlock</p> <p>Step off the pedal, check safety, and operate the chair.</p> <p style="text-align: center;">Locked functions</p> <p>All chair operations</p>

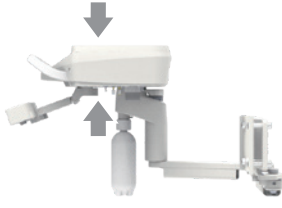
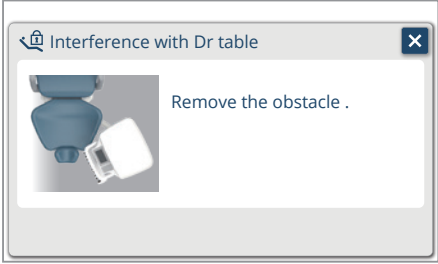

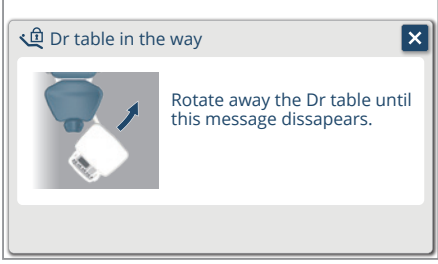
# 5 Operation





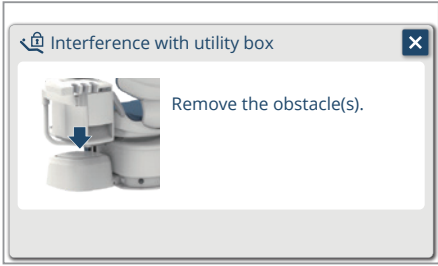

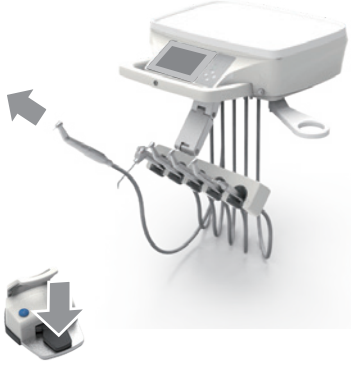

<p style="text-align: center;">Condition 3</p> <p>When the force is applied to the doctor unit in the direction indicated with an arrow during the automatic operation of the chair (Base mount / Cabinet delivery)</p> <div style="display: flex; justify-content: space-around; align-items: center;"> <div style="text-align: center;">  <p>Base mount</p> </div> <div style="text-align: center;">  <p>Cabinet delivery</p> </div> </div>	<p style="text-align: center;">Touch panel indication</p> <div style="border: 1px solid gray; padding: 10px; margin-bottom: 10px;"> <p>Interference with Dr table</p>  </div> <p style="text-align: center;">How to unlock</p> <p>Remove the obstacle that has caused emergency stop, confirm safety, and operate the chair.</p> <p style="text-align: center;">Locked functions</p> <p>Automatic operations of the chair</p>
<p style="text-align: center;">Condition 4</p> <p>When the doctor arm is rotated to moving area during the automatic operation of the chair (Base mount)</p> <div style="text-align: center;">  <p>doctor arm 30°</p> </div>	<p style="text-align: center;">Touch panel indication</p> <div style="border: 1px solid gray; padding: 10px; margin-bottom: 10px;"> <p>Dr table in the way</p>  </div> <p style="text-align: center;">How to unlock</p> <p>Rotate the doctor table until the lock indication on the touch panel disappears.</p> <p style="text-align: center;">Locked functions</p> <p>Automatic operations of the chair</p>

# 5 Operation

<p style="text-align: center;">Condition 5</p> <p>When the force is applied to the assistant arm from the upward/downward direction during the automatic operation of the chair</p> 	<p style="text-align: center;">Touch panel indication</p>  <p style="text-align: center;">How to unlock</p> <p>Remove the obstacle that has caused emergency stop, confirm safety, and operate the chair.</p> <p style="text-align: center;">Locked functions</p> <p>Automatic operations of the chair</p>
<p style="text-align: center;">Condition 6</p> <p>When force is applied to the top surface of the junction box in the direction indicated with an arrow, the junction box lid will come off to activate the lock function, and the chair will stop after rising for a second.</p> 	<p style="text-align: center;">Touch panel indication</p>  <p style="text-align: center;">How to unlock</p> <p>Remove the obstacle that has caused the emergency stop, place the lid back, confirm safety, and operate the chair.</p> <p style="text-align: center;">Locked functions</p> <p>Automatic operations and manual operations of the chair (lowering)</p>

## 5-17-2 Handpiece lock function

When the lock function is activated, indications as listed below are displayed on the touch panel, and the handpiece cannot be used. The functions that become locked and the unlocking steps are as follows.

Condition	Touch panel indication
 <p>A handpiece is picked up from the instrument holder while the foot controller pedal is stepped on.</p>	<div data-bbox="911 613 1353 875" style="border: 1px solid black; padding: 5px;"> <p style="text-align: center; font-size: small;">E20:HP picked up while FC is on</p> <div style="display: flex; justify-content: space-between;"> <div style="text-align: center;"> <p style="font-size: x-small;">Patient</p>  <p style="font-size: x-small;">Adult</p> </div> <div style="text-align: center;"> <p style="font-size: x-small;">User</p>  </div> </div> <div style="display: flex; justify-content: space-around; margin-top: 5px;">      </div> <div style="display: flex; justify-content: space-between; font-size: x-small; margin-top: 5px;"> <span>Manual</span> <span>Heater OFF</span> <span>High</span> </div> </div> <div style="text-align: center; background-color: #cccccc; padding: 5px; margin-top: 10px;"> <p>How to unlock</p> </div> <p style="text-align: center;">Step off the foot controller pedal, and step again on it.</p> <div style="text-align: center; background-color: #cccccc; padding: 5px; margin-top: 10px;"> <p>Locked functions</p> </div> <p style="text-align: center;">Handpiece operations</p>

[Example of MX2]

Slide mode (Va/Fix)

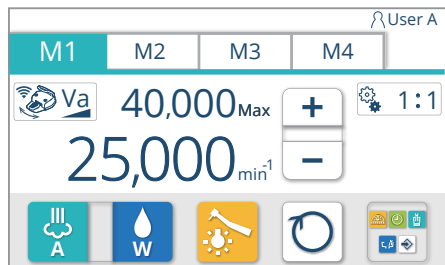

## 5-18 Micromotor Setting the micromotor slide mode (NBX/NLX plus/NLX nano/MX2/MCX)

When the micromotor is picked up from the instrument holder, the micromotor screen is displayed.

Memory can be selected from four memories (M1 to M4). The memories can be toggled by pressing the memory tab.

The slide mode can be selected from Va and Fix.

### Va (Variable)

By setting the maximum rotation, and sliding the foot controller pedal to the left or right, the rotation can be adjusted within the range of the maximum rotation.

The rotation is decreased by sliding to the left, and is increased by sliding to the right.

The rotation can be adjusted to the maximum rotation by stepping on the pedal.

### Fix (Fixed)

The rotation value can be adjusted up to the setting by the degree of step-in, regardless of the foot controller pedal position.

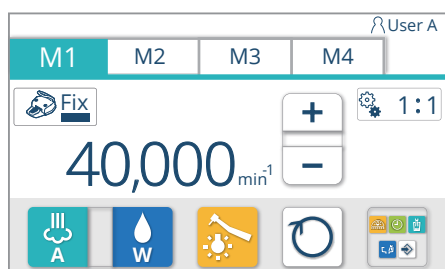
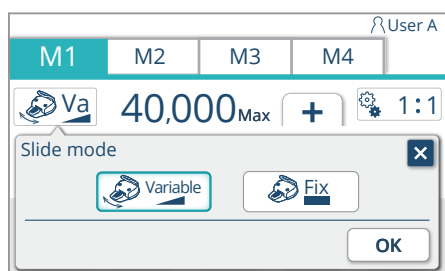
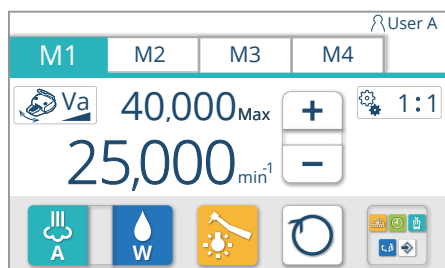

1. Pick up the micromotor from the instrument holder.

2. Press the slide mode  to display the slide mode setting screen.

3. Select a slide mode.

4. Memorize the selection by pressing .

The micromotor screen is displayed.

Settings of the slide mode are memorized in the starting condition after powering on.

\* To cancel the setting change, press  without pressing .

## Setting the maximum rotation (NBX/NLX plus/NLX nano/MX2/MCX)

[Example of MX2]

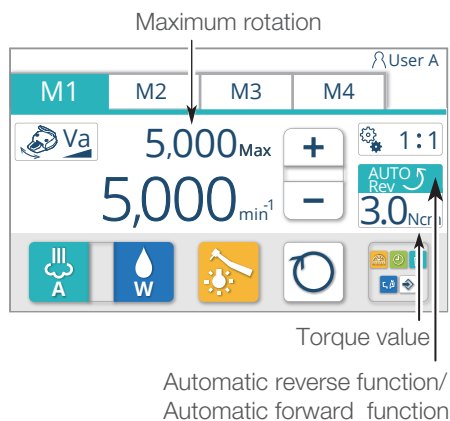

1. Pick up the micromotor from the instrument holder

2. Press the **+** **-** switch to set the maximum rotation  
The setting range of the maximum rotation varies depending on the model of the micromotor (see the figure below).

Automatic reverse function / automatic forward function and torque value are only displayed when setting the low-speed rotation range (NLX plus/MX2).

Micromotor model	Setting range of maximum rotation (gear ratio 1:1)								
	100	1000	2000	5000	6000	10000	20000	30000	40000
NBX				Rotation range					
				Interval of settable maximum rotation					
				Every 1,000					
NLX plus	Low-speed rotation range								
	Interval of settable maximum rotation								
	Every 100	Every 500							
			High-speed rotation range						
			Interval of settable maximum rotation						
			Every 1,000						
NLX nano				Rotation range					
				Interval of settable maximum rotation					
				Every 1,000					
MX2	Low-speed rotation range								
	Interval of settable maximum rotation								
	Every 100	Every 500							
				High-speed rotation range					
				Interval of settable maximum rotation					
				Every 1,000					
MCX				Rotation range					
				Interval of settable maximum rotation					
				Every 1,000					

(Unit: min<sup>-1</sup>)

## Memory setting for starting condition after powering on (NBX/NLX plus/NLX nano/MX2/MCX)

[Example of MX2]

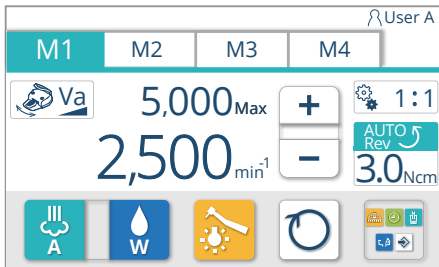

When the following setting of handpiece condition is changed, it can be memorized in the steps specified below.

- Maximum rotation



[Reference] Setting the maximum rotation [page 109]

- Spray condition (ON/OFF/Water/Air)

[Reference] Spray switch [page 95]

- Handpiece light condition (ON/OFF)

[Reference] Handpiece light switch [page 95]

1. Pick up the micromotor from the instrument holder
2. Select a memory tab M1 to M4 and press it
3. Change the handpiece condition (maximum rotation / spray / handpiece light condition).
4. Press the menu call switch  to call the menu screen
5. Press the store switch 

The memory setting screen for starting condition is displayed.



6. Confirm the displayed setting, and press  to memorize it.

\* If the  is not pressed but  is pressed, the changed setting is valid until the main switch is turned off, but the setting returns to before the change once the main switch is turned off.

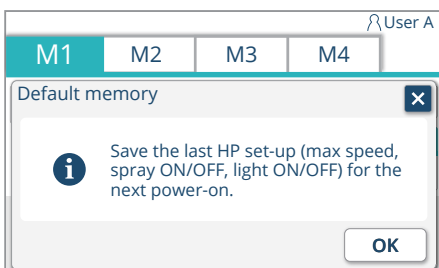

[Example of MX2]

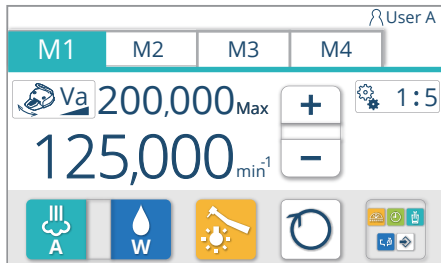
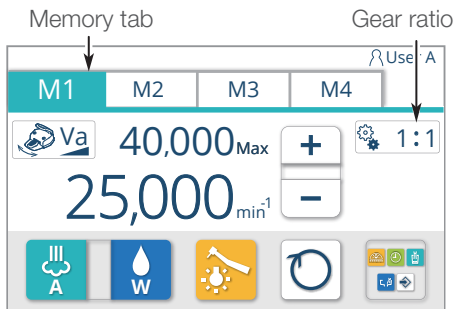

## Gear conversion display function (NBX/NLX plus/NLX nano/MX2/MCX)

This function is for indicating a value close to the actual rotation by converting the ratio of contra angle handpiece/ straight handpiece attached to the micromotor.

The following four kinds of gear ratio are used for conversion.

- 1:5 (five-fold speed), 1:1 (same speed),
- 4:1 (decelerated to one-quarter speed),
- 16:1 (decelerated to one-sixteenth speed)

1. Pick up the micromotor from the instrument holder.
2. Select a memory from the tab switch M1 to M4 and press it.
3. Press the gear ratio switch 1:1 to display the gear ratio switch setting screen.
4. Select a gear ratio.
5. Memorize the selection by pressing .

The micromotor screen is displayed.

Settings of gear ratio are memorized in the starting condition after powering on.

\* To cancel the setting change, press without pressing .

Displayed when the  
overheating prevention  
function is activated

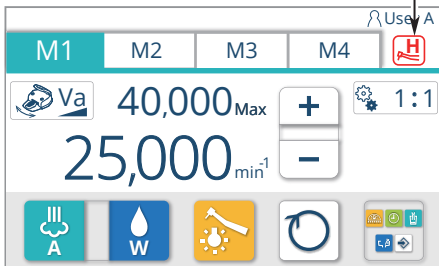

### Overheating prevention function (NBX/NLX plus/MX2/MCX)

If the product is used for a long time at a high load, the overheating prevention function is activated and the torque is automatically decreased, in order to prevent the micromotor unit overheating. If this occurs, a buzzer sound is heard, and  is displayed. While this indication is displayed, the overheating prevention function is activated.

By stopping rotation or using the product at a lower load, the overheating prevention function is deactivated after a certain time has elapsed.

### WARNING

Do not turn off and on again the main switch to deactivate the overheating prevention function. This may cause burn out due to the overheating of the micromotor unit.

### CAUTION

For proper use, be sure to carefully read the instructions for use attached to the relevant micromotor in advance.



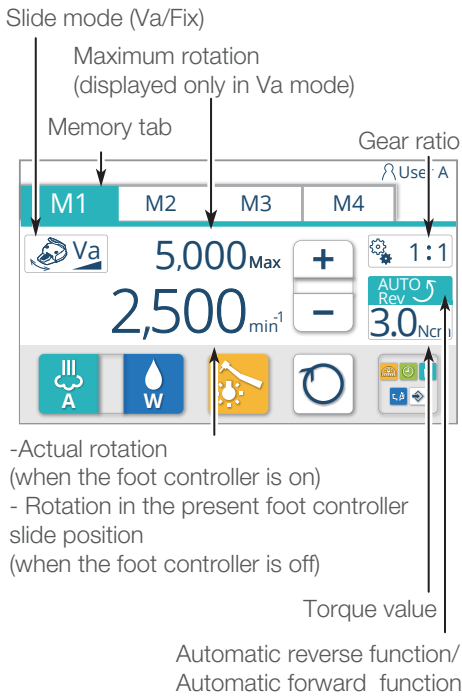

## NLX plus

In the case of micromotor NLX plus, if the maximum rotation is set in the low-speed rotation range (100 to 5,000 min<sup>-1</sup>), the torque value, the applicability of automatic reverse function, and the applicability of automatic forward function can be set.

Automatic reverse is a function that automatically switches to reverse rotation (counterclockwise) when the load exceeds the preset torque value in the low-speed rotation range (0.3-3.0 Ncm).

Automatic forward is a function that automatically switches to reverse rotation (counterclockwise) when the load exceeds the preset torque value in the low-speed rotation range (0.3-3.0 Ncm), and then returns again to forward rotation (clockwise) when the load disappears.

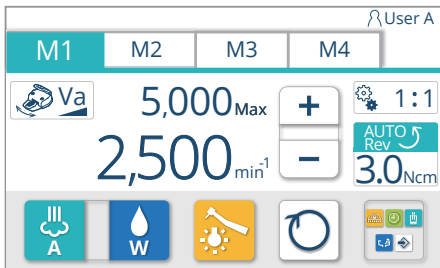

### Setting of a torque value

1. Pick up the micromotor from the instrument holder.
2. Select a memory from the tab switch M1 to M4 and press it.
3. Press the torque control switch to display the torque setting screen.

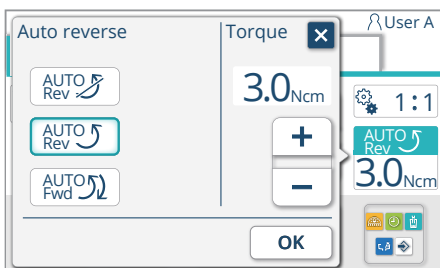

4. Press the switch to set to the required torque value.

<Value can be selected from:>

0.3/0.4/0.5/0.6/0.7/0.9/1.0/1.2/1.4/1.8/2.1/2.3/2.7/3.0

When is pressed, the torque value toggled upward among the options above.

When is pressed, the torque value is toggled downward among the options above.

5. Memorize the selection by pressing .

The micromotor screen is displayed.

Settings of torque value are memorized in the starting condition after powering on.

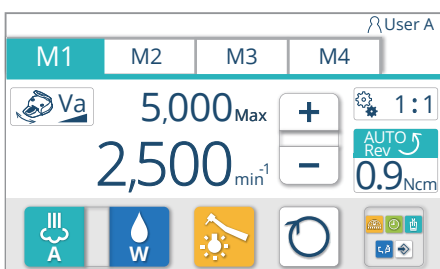

\* To cancel the setting change, press without pressing .

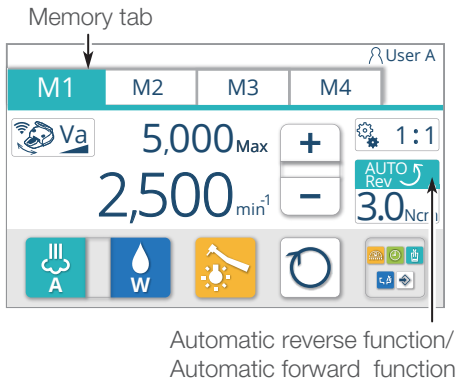

## Setting of automatic reverse function / automatic forward function

1. Pick up the micromotor from the instrument holder
2. Select a memory from the tab switch M1 to M4 and press it
3. Press the torque control switch to display the automatic reverse function / automatic forward function setting screen

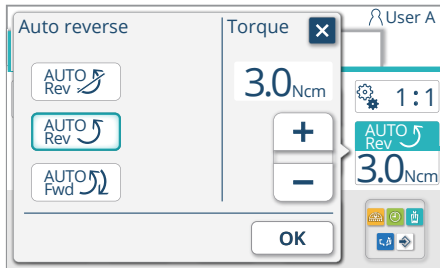

4. Select the required automatic reverse function / automatic forward function setting

- : Set to “No automatic reverse function”
- : Set to “Automatic reverse function”
- : Set to “Automatic forward function”

5. Memorize the selection by pressing

The micromotor screen is displayed.

Settings of automatic reverse function and automatic forward function are memorized in the starting condition after powering on.

\* To cancel the setting change, press  without pressing

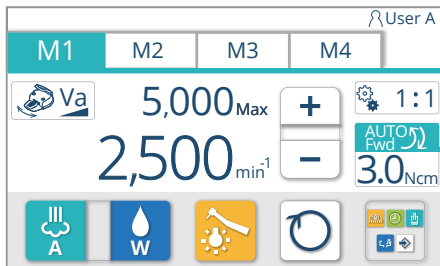

## CAUTION

If a reverse screw-shaped file, etc. is attached to NLX plus, be sure to set to “No automatic reverse function”, and switch the rotation direction using the forward/reverse switch on the micromotor. If that unit is set to “Automatic reverse function / automatic forward function”, the file may get damaged, resulting in injury.

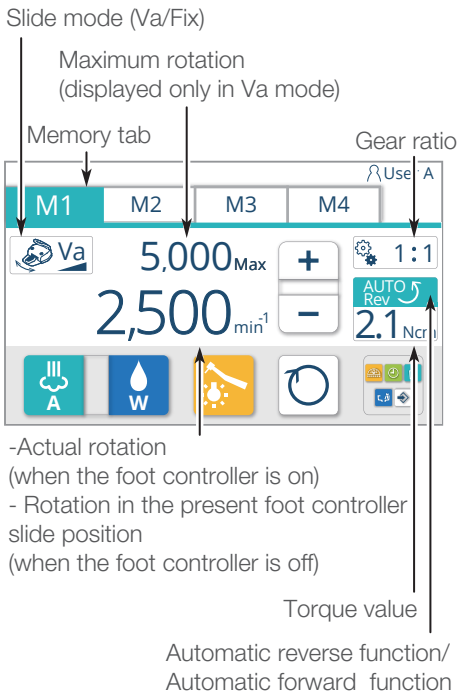

## MX2

In the case of micromotor MX2, if the maximum rotation is set in the low-speed rotation range (100 to 5000 min<sup>-1</sup>), the torque value, the applicability of automatic reverse function, the applicability of automatic forward function, and the time of automatic forward function duration can be set. The applicability of reciprocal mode can be set.

Automatic reverse is a function that automatically switches to reverse rotation (counterclockwise) when the load exceeds the preset torque value in the low-speed rotation range (0.4-3.5 Ncm).

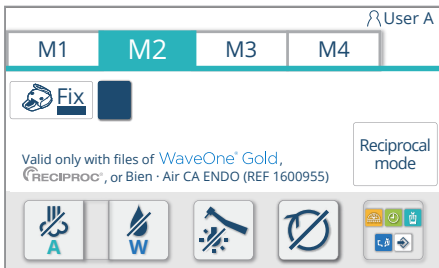

Automatic forward is a function that automatically switches to reverse rotation (counterclockwise) when the load exceeds the preset torque value in the low-speed rotation range (0.4-3.5 Ncm), and then returns again to forward rotation (clockwise) after the specified time of duration (automatic forward duration).



In reciprocal mode, the micromotor oscillates at preset angle, acceleration speed, and torque value.

This mode allows start or stop operation only.

\*Rotation speed cannot be adjusted.

When stepping on the foot switch,  is displayed as shown in the left figure. When not stepping on the foot switch,  is displayed.

Setting of     at the bottom of the screen cannot be changed.

To use the reciprocal mode, designated contra-angle and files are necessary.

Designated contra-angle is shown below:

CA ENDO (REF 1600955) by Bien Air





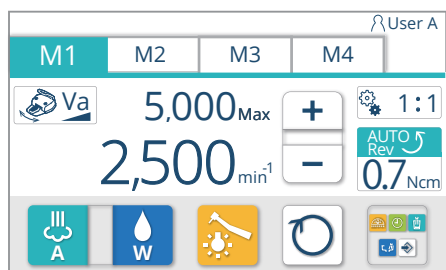
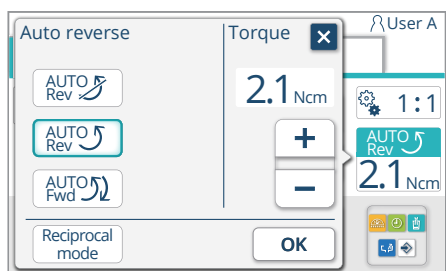
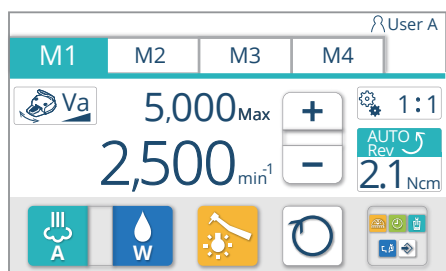

Designated files are shown below:

WaveOne® Gold by Dentsply Maillefer

 RECIPROC® by VDW



## Setting of a torque value

1. Pick up the micromotor from the instrument holder
2. Select a memory from the tab switch M1 to M4 and press it
3. Press the torque control switch  to display the torque setting screen
4. Press the   switch to set to the required torque value  
 <Value can be selected from:>  
 0.3/0.4/0.5/0.6/0.7/0.9/1.0/1.2/1.4/1.8/2.1/2.3/2.7/3.0  
 When the  switch is pressed, the torque value toggled upward among the options above.  
 When the  switch is pressed, the torque value is toggled downward among the options above.
5. Memorize the selection by pressing  The micromotor screen is displayed.

\* To cancel the setting change, press  without pressing 

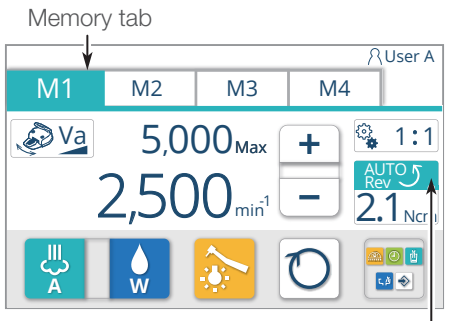



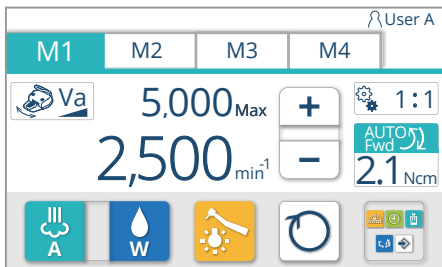
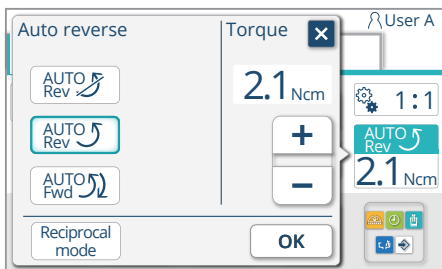

Automatic reverse function/  
Automatic forward function



## Setting of automatic reverse function / automatic forward function

1. Pick up the micromotor from the instrument holder
2. Select a memory from the tab switch M1 to M4 and press it
3. Press the torque control switch  to display the automatic reverse function / automatic forward function setting screen

## 4. Select the required automatic reverse function / automatic forward function setting

-  : Set to “No automatic reverse function”
-  : Set to “Automatic reverse function”
-  : Set to “Automatic forward function”
-  : Set to “Reciprocal mode”

[Reference] Setting the reciprocal mode  
[page 119 to 121]

## 5. Memorize the selection by pressing

The micromotor screen is displayed.

Settings of automatic reverse function, automatic forward function, and reciprocal mode are memorized in the starting condition after powering on.

\* To cancel the setting change, press  without pressing 

## CAUTION



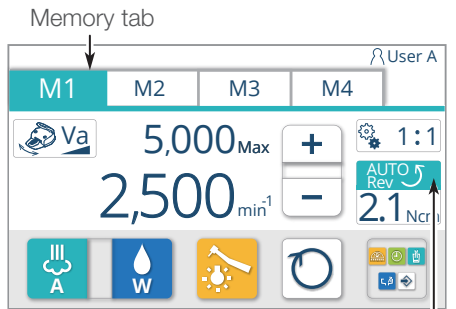

If a reverse screw-shaped file, etc. is attached to MX2, be sure to set to “No automatic reverse function”, and switch the rotation direction using the forward/reverse switch on the micromotor.

If that unit is set to “Automatic reverse function / automatic forward function”, the file may get damaged, resulting in injury.



Automatic reverse function/  
Automatic forward function

## Setting of automatic forward function duration

1. Pick up the micromotor from the instrument holder
2. Select a memory from the tab switch M1 to M4 and press it
3. Press the torque control switch  to display the automatic reverse function screen
4. Select automatic forward function  from the automatic reverse function / automatic forward function setting
5. Press the  switch to select from 0.0-25.4 seconds  
The selection can be made at an interval of 0.1 second.  
If pressing and holding the  switch, the time interval is 0.5 second.
6. Memorize the selection by pressing   
The micromotor screen is displayed.  
Settings of automatic forward duration are memorized in the starting condition after powering on.

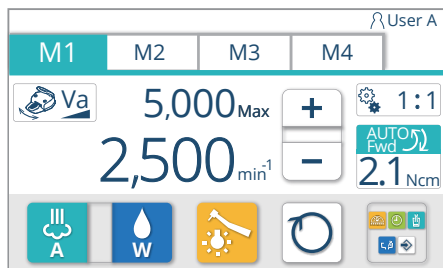
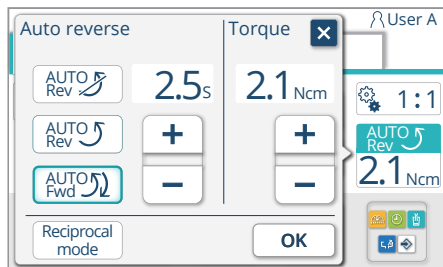

\* To cancel the setting change, press  without pressing 

(Example) Micromotor MX2 Auto-Rev

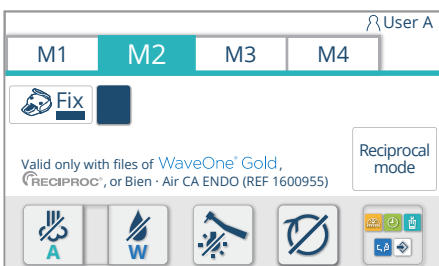
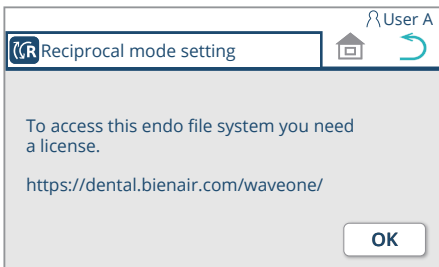
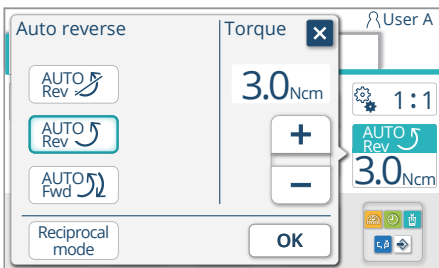
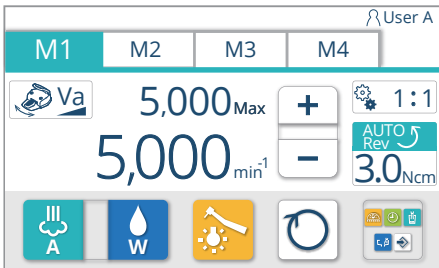

## Setting the reciprocal mode

### Startup setting

1. Pick up the micromotor from the instrument holder
  2. Set the rotation speed at 5000 min<sup>-1</sup> or less by pressing
  3. Press the torque control switch **3.0<sub>Ncm</sub>**
  4. Press the reciprocal switch **Reciprocal mode**  
 When the reciprocal switch is selected, the frame color of it turns blue.  
 \* switch is not displayed when the setting language is Japanese, or the micromotor except MX2 is used.  
 \* Pressing switch returns the display to the micromotor screen.
  5. Press **OK** switch  
 The display requests you to obtain a license.  
 \* Procedures 6 to 9 described below are displayed at first setting only.  
 After setting is completed, the micromotor screen is displayed.  
 \* Pressing switch returns the display to the torque setting screen.
  6. Press **OK** switch  
 The screen for entering activation code is displayed.
  7. Obtain the activation code from the following website  
 [Reference] How to obtain the activation code [Page 121]  
<https://dental.bienair.com/waveone/>  
 When obtaining the activation code, ID code shown at the top-left of screen is necessary.
  8. Enter the activation code obtained in Procedure 7.
- When switching alphanumeric input, press the alphanumeric switch . Each press of the switch alternates the display in the order of - - .
9. After entering the code, press **OK** switch  
 After a buzzer sound is heard, micromotor screen is displayed.  
 Setting of the reciprocal mode is memorized in the starting condition after powering on.

# 5 Operation

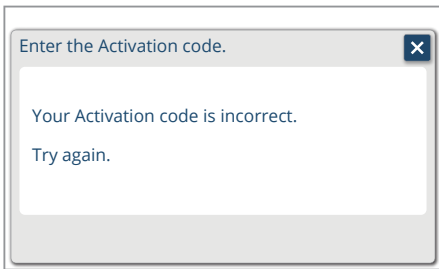

If the activation code is incorrect, the screen shown in the left is displayed.  
After pressing the switch, resume the setting from Procedure 8.

## Canceling the reciprocal mode

1. Pick up the micromotor from the instrument holder  
Micromotor screen is displayed.

2. Press the switch.

3. Press one of the following switches, , , or



When the switch is selected, the frame color of it turns blue.

\* Pressing switch returns the display to the micromotor screen.

4. Press switch

Micromotor screen is displayed.

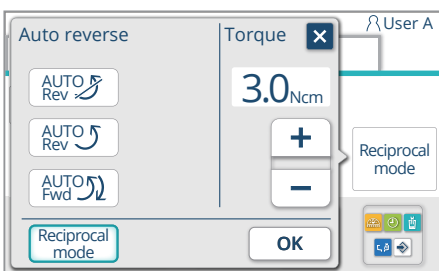
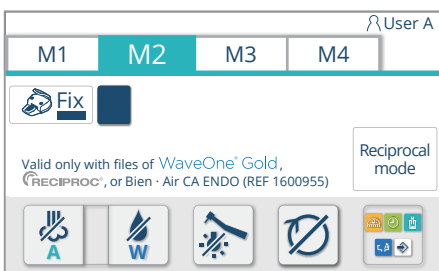

(Example) Micromotor MX2 Auto-Rev

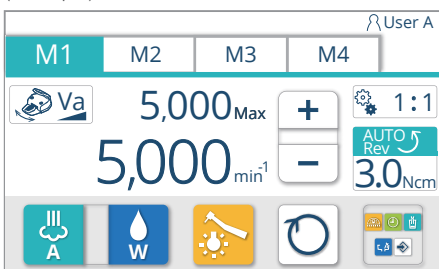



## How to obtain the activation code

Website for obtaining activation code



Select the "Dental unit" shown in the left figure.

Screen for entering information

1. Enter the following information into the box 1 to 6.
  - 1 Select "Belmont"
  - 2 Enter your name
  - 3 Enter your address
  - 4 Enter your email address
  - 5 Enter the license code contained in the box of contra-angle.
  - 6 Enter the ID code displayed on the touch panel of the doctor unit.  
[Reference] Setting the reciprocal mode— Startup setting— 7. [Page 119]
2. Enter the information into the box 1 to 6 and press **GENERATE THE ACTIVATION CODE**. Activation code will be displayed in the box 7.
3. Enter the obtained activation code into the box when prompted in Procedure 8— Startup setting— Setting the reciprocal mode [Page 119].

The content of display is subject to change without notice.

## 5-19 Ultrasonic scaler Perio/Endo/Scaling switch setting

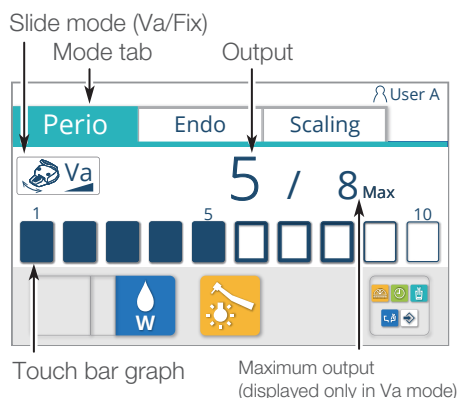

(Example of indication)  
Maximum output: 8; Output: 5

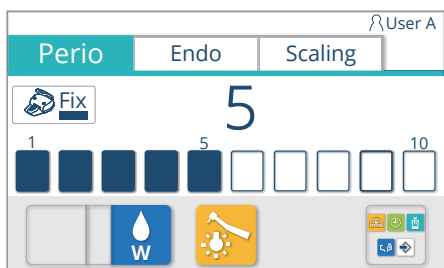
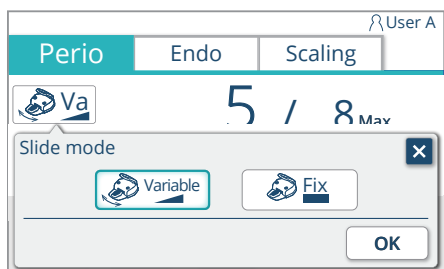
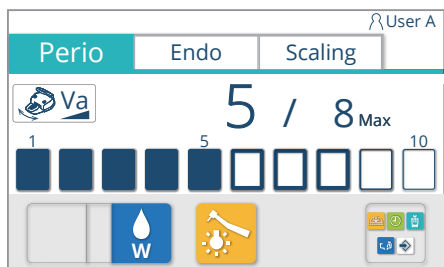
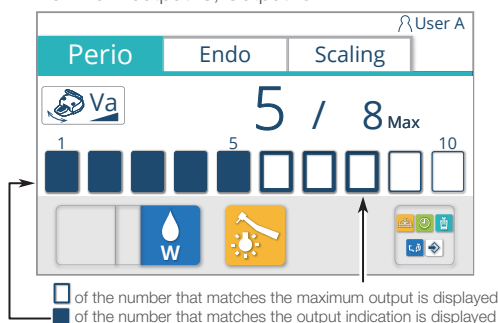

When the ultrasonic scaler is picked up from the instrument holder, the electric scaler screen is displayed, and the mode is displayed at the top left.

The mode can be selected from “Perio”, “Endo”, and “Scaling”.  
The mode is toggled by pressing the mode tab.

\* When using NO PAIN, the mode cannot be selected.

The slide mode can be selected from Va or Fix.

### Va (Variable)

By sliding the foot controller pedal to the left or right, the output can be adjusted within the range of the maximum output.

The output is decreased by sliding to the left, and is increased by sliding to the right.

The touch bar graph and output indication are displayed in accordance with the pedal slide position.

The maximum output setting can be changed using the touch bar graph .

Output of the electric scaler cannot be changed when the scaler is in operation. After turning off the scaler, change the output by using the touch bar graph.

### Fix (Fixed)

The output is fixed only with the set value.

1. Pick up the ultrasonic scaler from the instrument holder
  2. Press the slide mode switch to display the slide mode setting screen
  3. Select a slide mode
  4. Memorize the selection by pressing **OK**
- The electric scaler screen is displayed.  
Settings of the slide mode are memorized in the starting condition after powering on.

\* To cancel the setting change, press without pressing **OK**

Slide mode Va

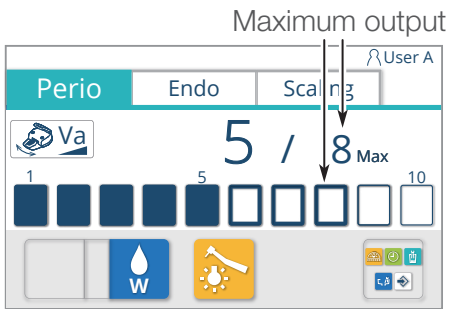

## Setting of the maximum output in the slide mode Va

1. Pick up the ultrasonic scaler from the instrument holder
2. Press the touch bar graph  that corresponds to the required maximum output value, and select the maximum output between 1 and 10

Slide mode Fix

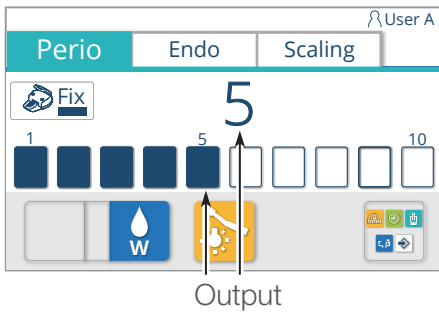

## Setting of the maximum output in the slide mode Fix

1. Pick up the ultrasonic scaler from the instrument holder
2. Press the touch bar graph  that corresponds to the required output value, and select the output between 1 and 10





For proper use, be sure to carefully read the instructions for use attached to the relevant scaler in advance.

## Memory setting for starting condition after powering on

When the following setting of handpiece condition is changed, it can be memorized in the steps specified below.

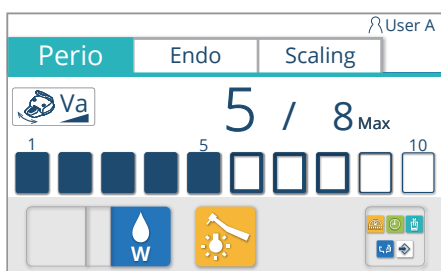
- Maximum output  
[Reference] Setting of the maximum output [page 123]
- Handpiece light condition (ON/OFF)  
[Reference] Handpiece light switch [page 95]



1. Pick up the ultrasonic scaler from the instrument holder
2. Select a mode from the mode tab and press it
3. Change the handpiece condition (maximum rotation / spray / handpiece light condition).
4. Press the menu call switch  to call the menu screen

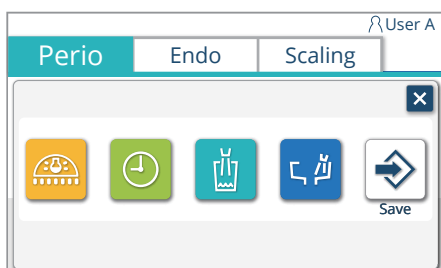

5. Press the store switch . The memory setting screen for starting condition is displayed.

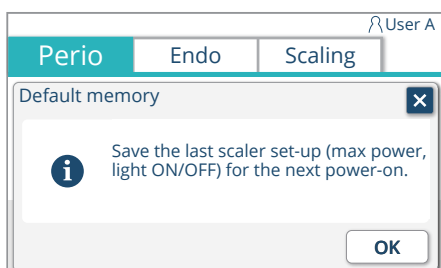

6. Confirm the setting to be recorded, and press  to memorize it.

\* If  is not pressed but  is pressed, the changed setting is valid until the main switch is turned off, but the setting returns to before the change once the main switch is turned off.



For proper use, be sure to carefully read the instructions for use attached to the relevant scaler in advance.

## 5-20 Air turbine/motor Setting of the slide mode

The initial setting of a handpiece upon powering on can be copied to another user memory.

When the air turbine/motor is picked up from the instrument holder, the turbine screen is displayed.

Memory can be selected from four memories (M1 to M4). The memory number can be switched by pressing the memory tab.

The slide mode can be selected either Va or Fix.

The memory of the air turbine/motor cannot be set individually for Va and Fix.

The Va and Fix setting must be common among M1 through M4.

### Va (Variable)

Set the maximum output as explained in [Page 126].

In operation, the output can be adjusted within the range of this maximum output by sliding the foot control pedal to left (to decrease) or right (to increase) or by depressing (to increase) or releasing (to decrease) the pedal.

### Fix

Set the maximum output as explained in [Page 126].

The upper limit output can be adjusted to the maximum output value by depressing the pedal regardless of the position of the pedal for the foot controller.

1. Pick up the air turbine/motor from the instrument holder

2. Press the slide mode switch  to display the slide mode setting screen

3. Select a slide mode

4. Memorize the selection by pressing   
The turbine screen is displayed.

\* To cancel the setting change, press  without pressing 

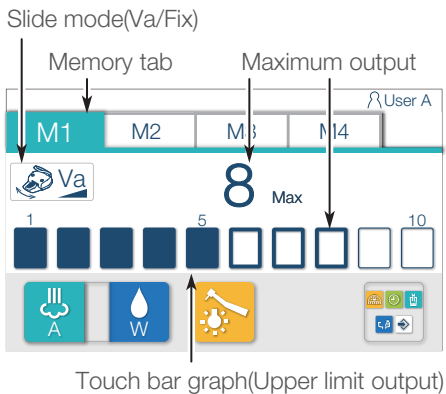

Touch bar graph(Upper limit output)

(Example of indication)  
Maximum output: 10 / Operating output: 5

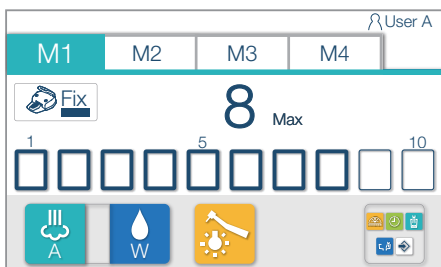
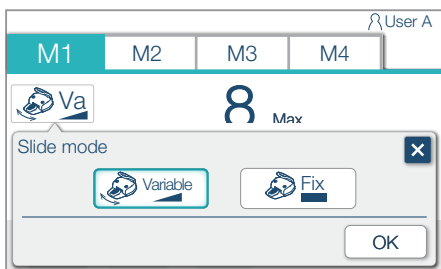
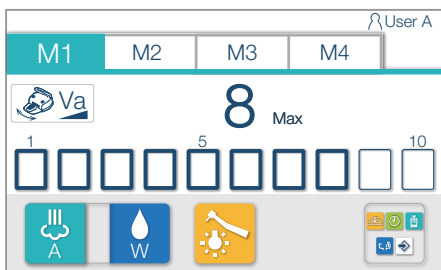
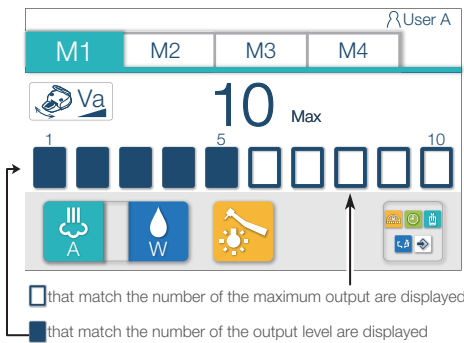

## 5 Operation

(Example of indication)

Maximum output : Change from 8 to 10

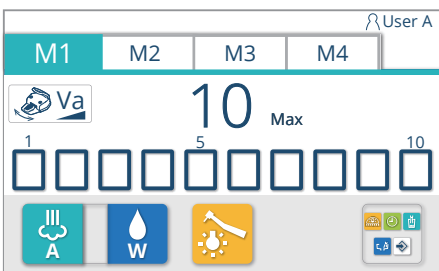
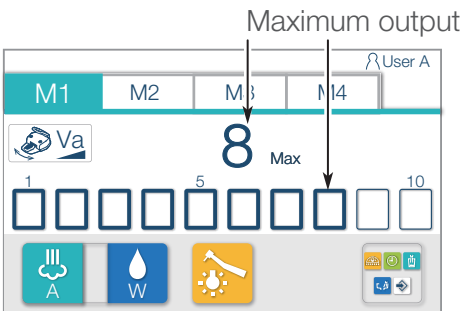

### Setting of the maximum output

1. Pick up the air turbine/motor from the instrument holder
2. Press the touch bar graph  that corresponds to the required maximum output value, and select the maximum output between 1 and 10

## Memory setting for starting condition after powering on

When the following setting of handpiece condition is changed, it can be memorized in the steps specified below.

- Maximum output  
[Reference] Setting of the maximum output [page 126]
- Spray condition (ON/OFF/Water/Air)  
[Reference] Spray switch [page 95]
- Handpiece light condition (ON/OFF)  
[Reference] Handpiece light switch [page 95]

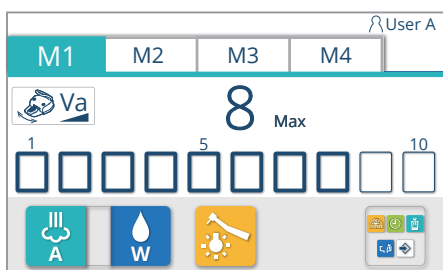

1. Pick up the air turbine/motor from the instrument holder
2. Select a memory from the tab switch M1 to M4 and press it
3. Change the handpiece condition (maximum output / spray / handpiece light condition)
4. Press the menu call switch  to call the menu screen

5. Press the store switch 

The memory setting screen for starting condition is displayed.

6. Confirm the displayed setting, and press  to memorize it

\* If  is not pressed but  is pressed, the changed setting is valid until the main switch is turned off, but the setting returns to before the change once the main switch is turned off.

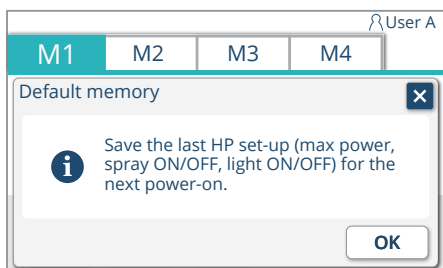
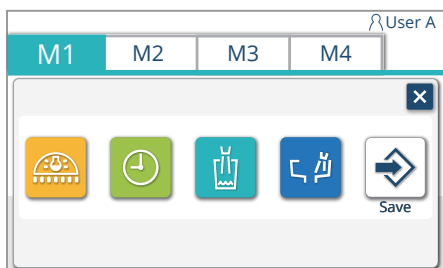

For proper use, be sure to carefully read the instructions for use attached to the relevant air turbine/motor in advance.

### 5-21 Syringes

BT14 3WAY syringe  
77-type 3WAY syringe  
LUZZANI 6WAY syringe L  
LUZZANI 3WAY syringe  
DCI syringe

#### CAUTION

For proper use, be sure to carefully read the instructions for use attached to the relevant syringe in advance.

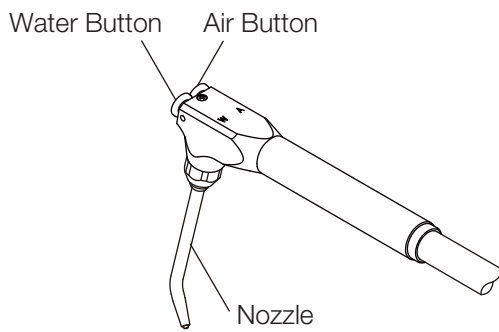

#### 77-type 3WAY syringe Operation

Depressing either or both buttons, this syringe offers air, water and spray. Syringe tip can be rotated freely.



### 5-22 Foot controller (wired/wireless)

#### Pedal

<When using the micromotor>

The rotation and output can be adjusted by the levels of pedal sliding and stepping.  
(Within the range of the indicated maximum rotation)

In Va mode, the rotation is decreased by sliding the pedal to the left, and is increased by sliding it to the right.

<When using the air turbine/motor>

Operation is only possible at a maximum output of 10 max, and on/off operation can be performed by stepping. It is not possible to adjust the output by the levels of sliding/stepping.

<When using the ultrasonic scaler>

The operation is turned on by stepping on the pedal.

It is not possible to adjust the output by the levels of sliding during the operation.

\* Output of the electric scaler cannot be changed when the scaler is in operation. After turning off the scaler, change the output, then activate the scaler again.

The output can be adjusted by the level of pedal sliding.

It is not possible to adjust the output by the level of stepping.

(Within the range of indicated maximum output)

The present output is decreased by sliding the pedal to the left, and is increased by sliding it to the right.

#### Water on/off switch

The spray mode can be switched.

#### Chip air switch

Air is discharged from the chip of the micromotor or air turbine/motor.

#### Carrier

The foot controller can be moved by hanging it over the foot.

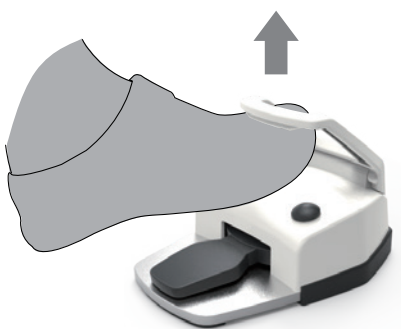
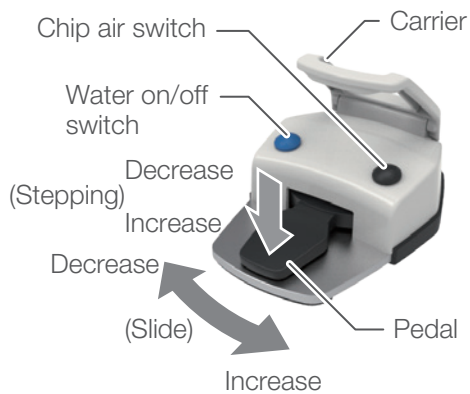

The batteries are not included. Insert the batteries referring to "How to replace batteries of the wireless foot controller" [page 131].

### 5-22-1 Confirmation of the pairing of the wireless foot controller

On the wireless foot controller and on the side of the cuspidor unit, stickers indicating the pairing identification code are attached. Confirm that the same pairing identification code is indicated.

Cuspidor Unit type



Vac Pac Unit type

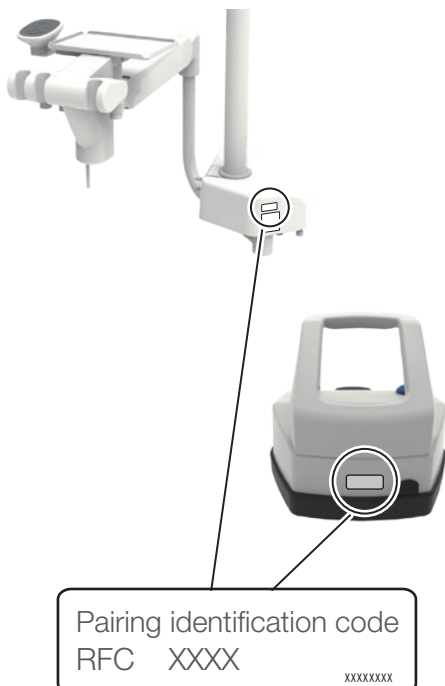

Operate the wireless foot controller within one meter of the product.

 **WARNING**

If more than one unit of the product is used on the same floor, be careful not to operate a wireless foot controller that is paired with another unit.

### 5-22-2 How to replace batteries of the wireless foot controller

When the battery level indication on the home screen becomes , promptly replace the batteries with new ones.

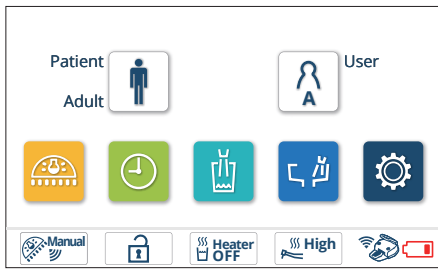

#### 1. Turn off the main switch

#### 2. Remove the covers of the two battery boxes on the back of the wireless foot controller

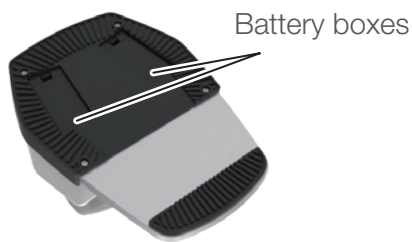

### CAUTION

Turn off the main switch when replacing batteries. Otherwise, switches or a pedal is accidentally pressed resulting in unintentional movement, leading to any damage or injury, or the product may not operate normally.

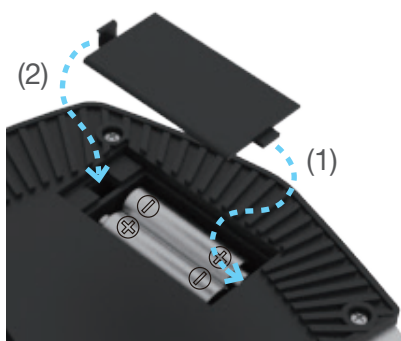
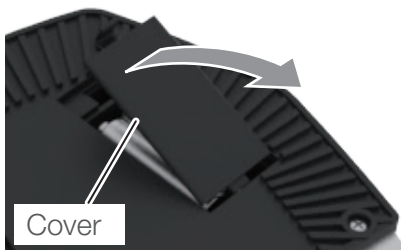

#### 3. Insert two new/charged AA batteries into each box. Use alkali dry batteries or NiMH batteries.

Be careful to put each battery in the correct direction (positive/negative).

#### 4. Attach the cover of each battery box in order indicated with arrows (1, 2).

### CAUTION

Do not use batteries other than the specified types. Do not mix new batteries with old ones, or mix different types of batteries (e.g. alkali dry batteries with NiMH batteries). Note that improper use of batteries causes leakage or rupture.

Take out batteries if the unit is not to be used for one week or longer.

### Connection point

There is a connection point where the rubber cap is removed.

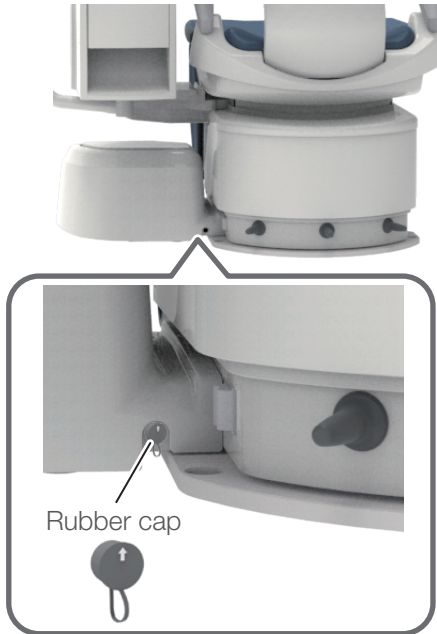

### Wireless foot controller

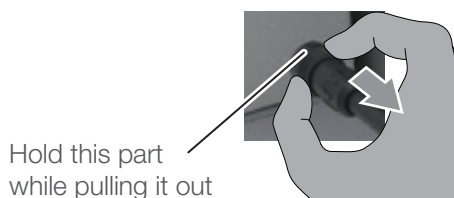
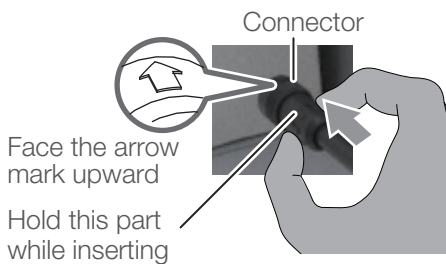

### 5-22-3 Cable connection of a wireless foot controller

If the wireless foot controller does not operate normally even after replacing the batteries, the unit can be used by connecting the cable contained in the package.

Electric wave used for the wireless foot controller could be interrupted depending on the conditions where the product is used, which might affect the functions of the handpiece. This is not the malfunction of the product.

Be sure to turn off the main switch before connecting the cable. Otherwise, the unit may fail to operate normally.

Before using the cable, take batteries out of the battery boxes. Otherwise, the unit may fail to operate normally.

When removing the cable, be sure to hold the indicated part while pulling it out. Otherwise, disconnection may result.

Cable connection is only for temporary use, and must not be used permanently.

#### How to connect

When connecting the cable to the chair or cuspidor unit, remove the rubber cap, and insert the connector until it clicks, with the arrow mark facing upward.

The same applies when connecting the cable to the wireless foot controller side.

\* Keep the rubber cap of the wireless foot controller to avoid losing it.

#### How to remove

When removing the cable, be sure to hold the part indicated in the figure while pulling it out, and then attach the rubber cap.

Be sure to attach the rubber cap before using the unit. Use without attaching the rubber cap allows the entry of dust and water, resulting in failure.

### 5-22-4 Operating precautions for the wireless foot controller

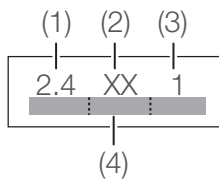

Radio-frequency interference with this product.

This product contains radio equipment that uses the full 2.4 GHz band ((1)), and interference with the mobile identifier band ((4)) is unavoidable. The FSK system ((2)) is employed as a modulation method, and the assumed interference distance is 10 meters ((3)). The assumed interference distance means the distance at which radio-frequency interference on premises radio stations or specified low power radio stations is anticipated.

Many other devices, including those described below, use the same frequency band as this product: Industrial devices such as microwave ovens, scientific and medical devices, premises radio stations for mobile object identification used for production lines in plants (radio stations that require a license), specified low-power radio stations (radio stations that require no license), and amateur radio stations (radio stations that require a license).

1) Check that no premise radio stations for mobile object identification or specified low-power radio stations are operating in the vicinity before starting to use this product.

2) If you notice that this product causes hazardous radio-frequency interference on a premises radio station for mobile object identification, promptly stop all emissions of radio waves and contact your local authorized Belmont dealer.

3) If you encounter problems such as a case in which this product causes hazardous radio-frequency interference on a specified low-power radio station for mobile object identification, contact your local authorized Belmont dealer.

Devices listed below may cause radio-frequency interference in the 2.4-GHz band:

- Wireless LAN devices

Receipt computer (used in the hospital wireless environment), mouse, keyboard (Bluetooth, 2.4-GHz band), microscope, intraoral camera, panoramic X-ray equipment, CT, etc.

- Mobile object identification apparatus (such as antitheft devices, entry and exit monitoring systems, etc.)

- Others (such as cautery knives, microwave ovens, etc.)

#### Certification of equipment

Wireless instruments built into this product are certified as radio-frequency devices for low-power communications in accordance with the Radio Act.

Certificates are indicated on the radio-frequency equipment.

Therefore, no license is required to use this product. If you take any of the actions listed below with this product, however, you may violate the law and be punished.

- Disassembling or modifying the radio-frequency instruments built into this product

- Removing the certificate labels from the radio-frequency instruments built into this product

Specifications of the wireless foot controller

Transmission system: F1D (FSK)

Maximum transmission power: 1 mW

Battery: 4 × AA batteries

(Alkaline battery or NiMH (rechargeable) battery)

Battery life: Approx. 1,640 hours

- Using AA Eneloop batteries

- Used at practices for 15 to 20 patients per day

- Used 5 days per week, one of which it is used only in the morning

\* The battery life varies according to the use environment (frequency of use, radio quality, etc.).

\* Eneloop is a registered trademark of the Panasonic Group.

### 5-23 Maintenance panel



(1) Water service coupler

This switch turns on the water supply to an external device.

(2) Water supply control knob for the water service coupler

This knob adjust the quantity of water supplied to an external device.

(3) Air service coupler

Supplies air to an external device.

(4) Main switch

## 5-24 Handpiece (assistant holder)

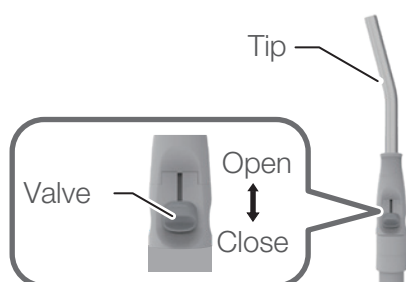

### Vacuum handpiece

Take the vacuum handpiece out of the assistant holder, and suction will start.

Since a delay circuit is provided, suction does not stop immediately when the vacuum handpiece is returned to the assistant holder. Suction will continue for approx. 4 seconds.

The suction volume may be controlled by opening or closing the valve.

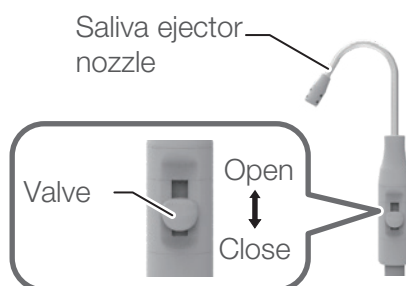

### Saliva ejector handpiece

Take the saliva ejector handpiece out of the assistant holder, and suction will start.

Since a delay circuit is provided, suction does not stop immediately when the saliva ejector handpiece is returned to the assistant holder. It will continue for approx. 4 seconds.

The suction volume may be controlled by opening or closing the valve.

## 5-25 Assistant hose clamp

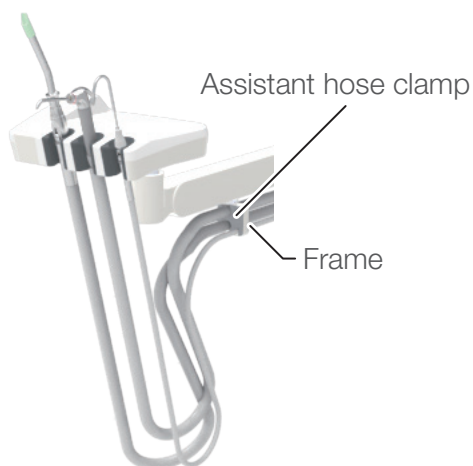

It is possible to fix the hose to prevent the handpiece hoses from contacting to the floor.

Assistant hose clamp is detachable from the frame, which is suitable for cleaning.

[Reference] Assistant hose clamp [page 201]

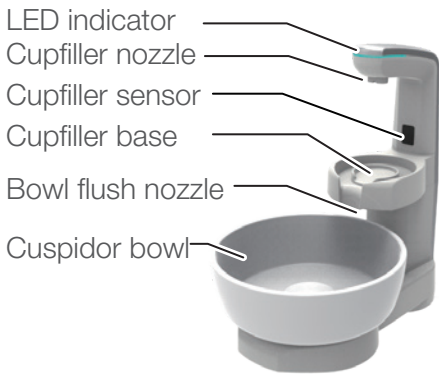

Touch panel

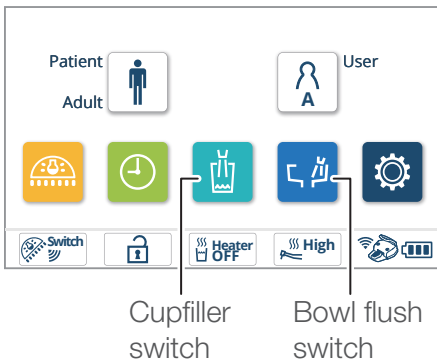



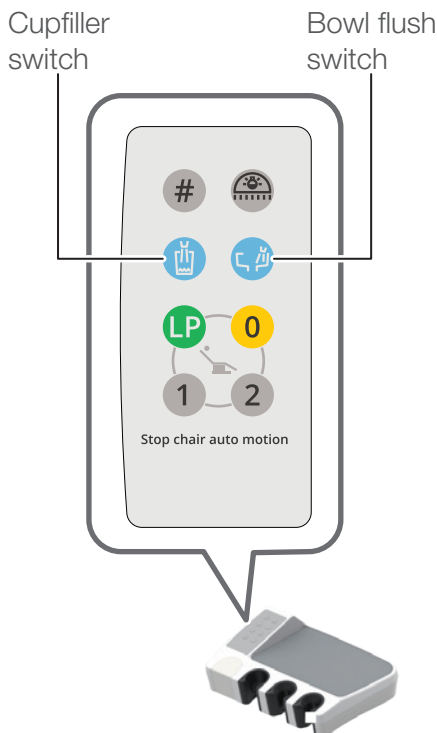



Assistant control panel





## 5-26 Filling a Cup

The following two methods can be selected to fill a cup:

- Auto-cupfiller with sensor control: Place a cup on the base, and it will be filled with water to the specified level. (Cup, water level detection)
- Manual cupfiller: Press the cupfiller switch to fill with water for a specified time.





	Cup-filling method
Auto-cupfiller with sensor control (Cup, water level detection)	<p>When a cup is placed on the cupfiller base, a sensor detects the cup, and fills it with the specified quantity of water.</p> <p>To interrupt filling, press the cupfiller switch   on the touch panel or assistant control panel.</p> <p>When a cup with some water remaining in it is placed on the cupfiller base, it will be filled with the correct reduced quantity of water.</p> <p>* Even when a fully-filled cup is placed on the base, a small quantity water will be supplied to detect the water level.</p> <p>[Ref] Setting the cupfiller water level [Page 178]</p>
Manual cupfiller	<p>When the cupfiller switch   on the touch panel or assistant control panel is pressed, water is supplied for the specified time.</p> <p>To interrupt filling, press the cupfiller switch   again.</p>

If “cuspidor bowl flush” is set to “continuous flush,” water is supplied from the bowl flush nozzle to flush the cuspidor bowl while the cup is filled.

To interrupt the flush, press the bowl flush switch   on the touch panel or assistant control panel.

If any droplet or dirt is attached on the surface of cupfiller sensor, the cupfiller may not work properly. In that case, wipe off the droplet or dirt after switching the sensor into disable mode.

### Sensor disable mode (Cupfiller base maintenance mode)

The sensor disable mode can be activated by holding down the cupfiller switch   on the touch panel or assistant control panel for 2 seconds or more. In the sensor disable mode, continuous beeps are emitted, and sensor control is disabled for the auto-cupfiller. The LED indicator on the cuspidor unit displays pink. To terminate the sensor disable mode, press the cupfiller switch   again. The LED indicator returns to its original color.



### 5-27 LED indicator

Color of the LED indicators show the status of the unit/chair.



Blue



Orange



Pink



#### 【ON, Blue】

All the functions are correctly provided.

#### 【ON, Orange】

The system is in either of the states described below:

- The chair lock function is activated.
- The handpiece lock function is activated.

[Ref] Chair lock function [Pages 103 to 106]

Handpiece lock function [Page 107]

#### 【Flickering Orange】

Water level in the water bottle is low.

#### 【ON, Pink】

The system is in either of the states described below:

- Sensor control for the auto-cupfiller is in the sensor disable mode.
- Operation mode of the dental light is in the switch mode.
- The cupfiller water level is now being set.

[Ref] Sensor disable mode [Page 136]

Operation mode of the dental light [Page 92]

Setting the cupfiller water level [Page 178]

Since the color of the LED indicator gives an indication of the status of the chair/handpiece lock or mode transition, always check that the LED indicator is functioning correctly before starting daily work..

### 5-28 Water bottle

Refill water when the water bottle level becomes low.

#### Replacing the water bottle

[How to remove the water bottle]

(1) Flip the BOTTLE AIR switch downward (OFF).



(2) Turn the water bottle and remove it.

Turning it counterclockwise will loosen the connection.

Turning it clockwise will tighten the connection.

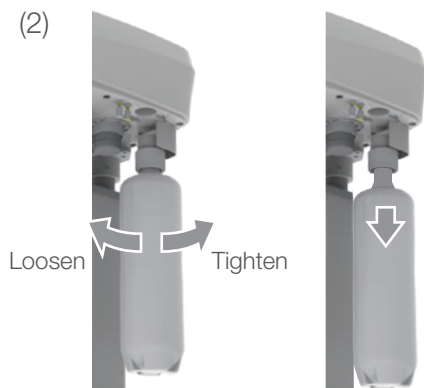

[How to attach it]

Reattach it in the reverse order of (1) to (4).

\* When not using the water from the water bottle, flip the WATER toggle switch backward (CITY).

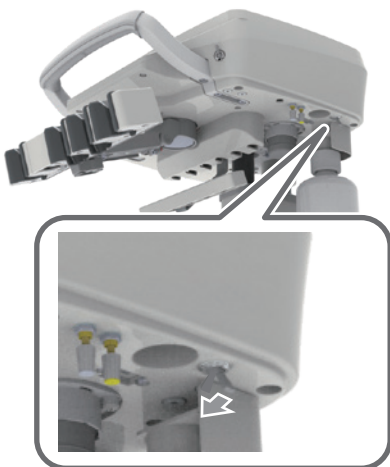

### 5-29 USB port

The USB port accepts a doctor table for a USB-type intraoral camera or other device.

Connecting cable should be necessary inside doctor table as per the specification of the device to be added.



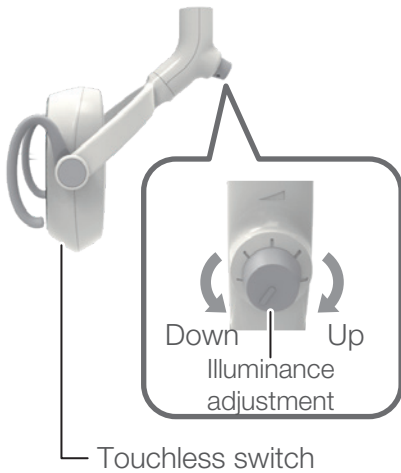

### 5-30 EURUS Light

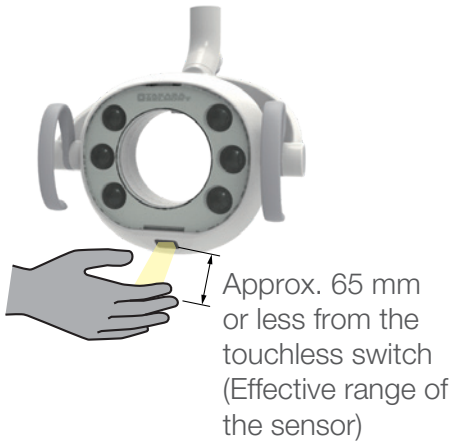

Touchless switch



Turn on the product's main switch; the dental light comes on and the indicator lights up.

The dental light can be turned on or off using the touchless switch or the dental light switch   on the touch panel or assistant control panel.

#### Turning the dental light on or off with the touchless switch.

The touchless switch is activated by a sensor. The sensor detects an object of the same width as the sensor window at a distance of approx. 65 mm or closer.



Move a hand across the switch to turn it on, and again to turn it off.

\* If the surface of the touchless switch is dirty, it may degrade the sensitivity of the switch. If the surface is dirty, clean it with a soft cloth.

#### Adjusting illuminance in the treatment mode

When the light is turned on in the treatment mode, the operator can adjust the illuminance steplessly between 3,000 and 28,000 lx by turning the illuminance controller shown in the figure on the left. Turn it clockwise viewed from the rear of the light head to increase the illuminance or counterclockwise to decrease it. The illuminance cannot be adjusted when the light is turned on under ON mode.

#### Switching from the treatment mode to Composite-Safe mode

Hold your hand over the touchless switch within the 65-mm range for the specified time, or press the dental light switch   on the touch panel of the assistant control panel for the specified time to change operation to the Composite-Safe mode.

The illuminance cannot be adjusted when the light is turned on under Composite-Safe mode.

Repeat the above step to switch operation back to the treatment mode.



\* When the light is turned off in the Composite-Safe mode and turned on again, it will be in the treatment mode.

 **CAUTION**

Before use, always read the Instructions for each dental light to ensure correct usage.

## 5-31 900 Dental Light

Turn on the product's main switch; the dental light turns on and the indicator displays in green.

The dental light can be turned on or off using the touchless switch or the dental light switch   on the touch panel or assistant control panel.

### Turning the dental light on or off with the touchless switch.

The touchless switch is activated by a sensor. The sensor detects an object at distance of approx. 65 mm or closer from the switch. Move a hand across the switch to turn it on, and again to turn it off.

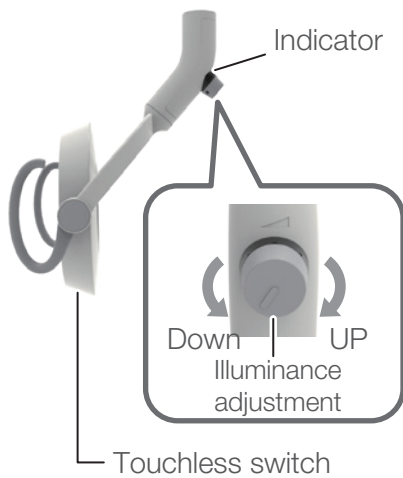

\* If the surface of the touchless switch is dirty, it may degrade the sensitivity of the switch. If the surface is dirty, clean it with a soft cloth.



### Adjusting the illuminance in the treatment mode

The illuminance can be adjusted between 4,000 and 35,500 lx by turning the illuminance controller.

### Switching from the treatment mode to Composite-Safe mode

Hold your hand over the touchless switch within the 65-mm range for the specified time, or press the dental light switch   on the touch panel of the assistant control panel for the specified time to switch operation to the Composite-Safe mode; the indicator flickers in green.

The illuminance cannot be adjusted when the light is turned on under Composite-Safe mode.

Repeat the above step to switch operation to the treatment mode; the indicator turns steady green.

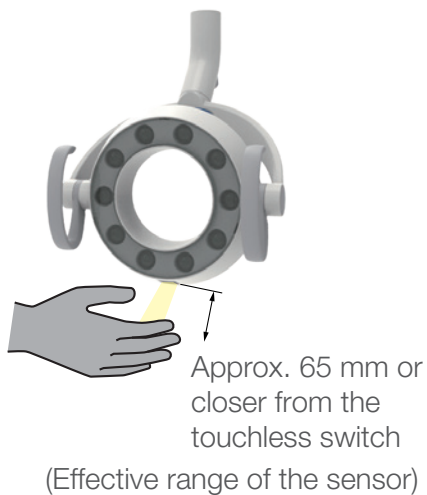

Mode	Indicator
Treatment mode	ON, Green
Composite-Safe mode	Flickering Green

\* When the light is turned off in the Composite-Safe mode and turned on again, it will be in the treatment mode.

## CAUTION

Before use, always read the Instructions for Use supplied with each dental light to ensure correct usage.

### 5-32 Monitor bracket

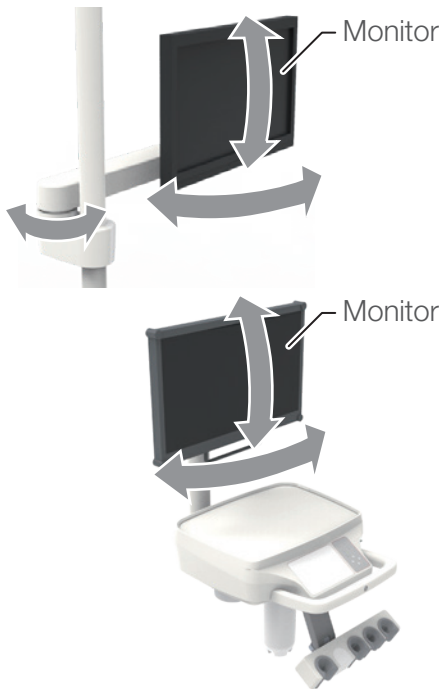

The monitor can be swung to a position where you can easily see it. When adjusting the position, hold the monitor while you move it.

When moving the monitor, do not let it touch the wall or other object.

### CAUTION

Do not apply an excessive load or shock to the monitor or monitor bracket. To avoid damage or injury, ensure that the monitor satisfies the following specifications:

Size: 21 inches      Weight: 6 kg

### 5-33 Panoramic viewer

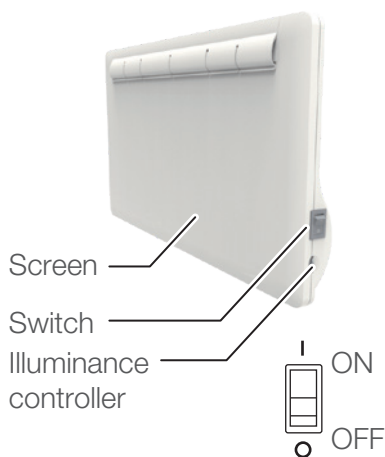

Turn the switch upward to turn on the screen and downward to turn it off.

Turn the luminance controller upward to increase the luminance and downward to lower it.

When it is not being used, turn it off.

The panoramic viewer is designed to supplement X-ray observation and is not for examination or diagnosis.

### 5-34 Dental viewer

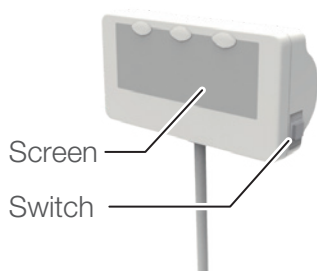

Press the switch to turn the screen on. Press it again to turn the screen off.

When it is not being used, turn it off.

The dental viewer is designed to supplement X-ray observation and not for examination or diagnosis.

### 6-1 Setting for automatic operation

#### 6-1-1 Setting the treatment and entry/exit positions

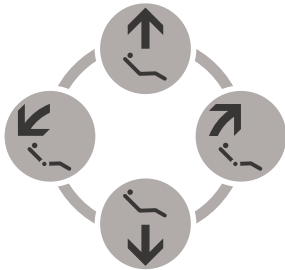

Manual control switches



Preset switches



Automatic return switch

1. Move the chair to the treatment position or entry/exit position using the manual control switch as required.

2. Press and hold the preset switch **1** or **2** (treatment position) or automatic return switch **0** (entry/exit position) for approx. 5 seconds. A beep sounds, and the chair is set to the position.

3. Move the chair away from the set position, and press the preset switch to check the chair moves to the set position.

\* The angle of the legrest and length the footrest projects are determined automatically based on the angle of the backrest when set.

[Ref] Angular relationship between the backrest, legrest, and footrest [Page 71]

#### 6-1-2 Setting the mouth rinsing position

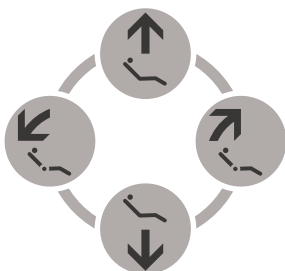

Manual control switches



Last position switch

1. Move the chair to the preset mouth rinsing position using the manual control switch.

2. Press and hold the last position switch **LP** for approx. 5 seconds. A beep sounds, and the chair is set to the position.

3. Move the chair away from the set position, and press the last position switch **LP** to check the chair moves to the set position.

\* The angle of the legrest and the length the footrest projects are automatically determined based on the angle of the backrest when set.

[Ref] Angular relationship between the backrest, legrest, and footrest [Page 71]

### 6-1-3 Freely setting the legrest angle

The legrest angle in auto mode is determined by the backrest angle. Change the legrest angle by the following the procedure below:

Membrane switches on the doctor control panel

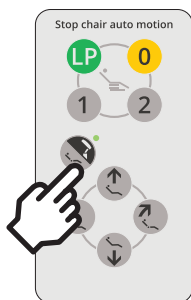









1. Move the seat of the chair and backrest to the desired position using the manual control switch or preset switch on the control panel. (The stick switch for manual/automatic operation can also be used to do the same.)

\* A stick switch may not be installed depending on which specifications you selected.



2. Press and hold the chair/headrest membrane switch  on the control panel for 5 seconds or more.



3. While the beeps are sounding, move the legrest to the desired angle.

Press the manual control switch  on the control panel, or turn the stick for manual control upward (in the  direction) to raise the legrest. Press the manual control switch  on the control panel, or turn the stick for manual control downward (in the  direction) to lower the legrest.

4. Press and hold the switch for 5 seconds or more to set (automatic return switch , last position switch , or preset switch  or  on the control panel) until a beep sounds, indicating that the setting has been saved.

(Or, keep turning the stick switch for automatic chair operation in the direction to set until a beep sounds, indicating that the setting has been saved.)

5. On completing the setting or to cancel the process without saving the setting, press the manual control switch  or  on the control panel.

(Or, turn the manual control stick switch to the right (in the  direction) or left (in the  direction).)

Bleeps stop, and the system returns to the normal state.



## 6-2 Function switch

Home screen

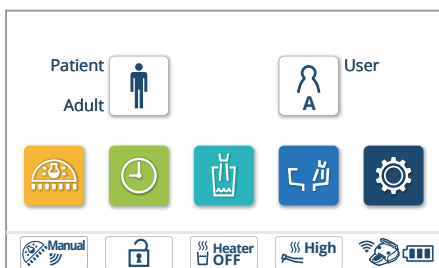

Press the function switch  on the Home screen to display the Function setting screen.

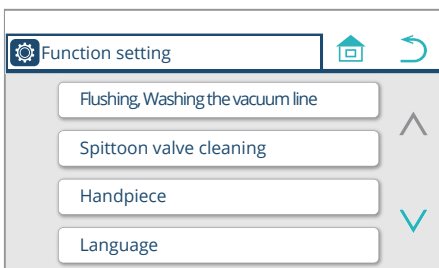

Select an item to display the corresponding setting screen.

Press the  switch to cancel operation and return from the current screen to the Home screen.

Press the  switch to cancel operation and return from the current screen to the previous screen.

Press the  switch to proceed to the next page.

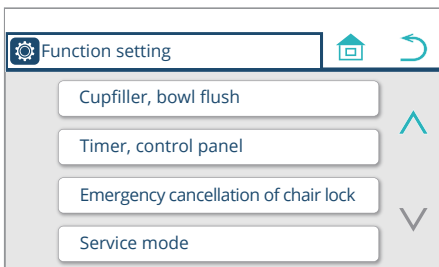

Press the  switch to return to the previous page.

### 6-2-1 Setting items with the function switch

Setting items appearing on the touch panel	
Flushing, Washing the vacuum line	
Flushing	Page 147
Washing the vacuum line	Page 156
Handpiece	
Drive air pressure	Page 173
Spray mode	Page 174
Handpiece light activation	Page 175
Micromotor light brightness	Page 176
Cup, bowl	
Cupfiller water level	Page 178
Interlock of cup-filling, bowl flush	Page 180
Bowl flush time	Page 181
Language	Page 182
Timer and control panel	
Timer alarm sound	Page 183
Key touch volume	Page 184
Sleep mode time	Page 185
Emergency cancellation chair lock	Page 186
Service mode	*

\*The service mode is designed exclusively for service engineers to carry out maintenance on this product.

## 6-2-2 Selecting the flushing method and carrying out flushing

### Cuspidor Unit type

#### To flush the water circuit of the handpiece alone

1. Press the function switch  .  
The Function setting screen appears.

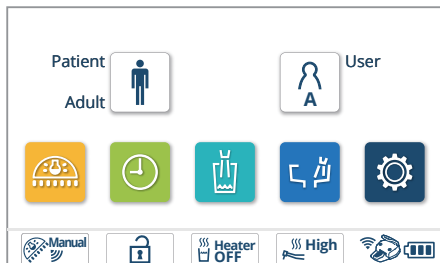

2. Press the 'Flushing, Washing the vacuum line' switch.

If the washing function for vacuum line is not equipped, 'Flushing' appears on the screen instead. Procedures shown below are not applicable.

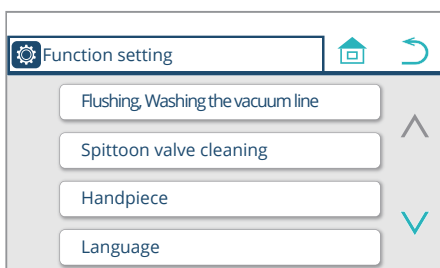

3. Press the 'Flushing' switch.

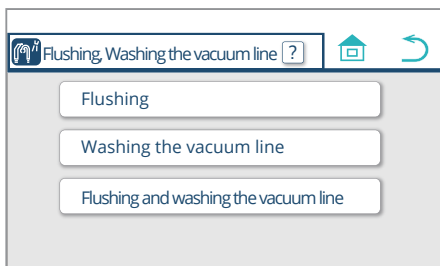

4. Check that 'Short mode 00:40' is selected, and press  .

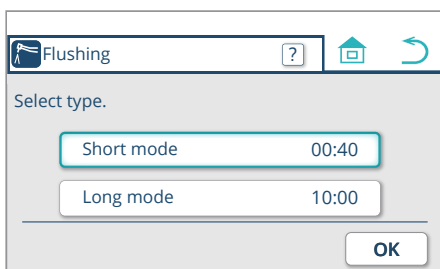

\* When using the timer, the screen shown in the figure on the left is displayed.

Press  to cancel flushing.  
Press  to start flushing.

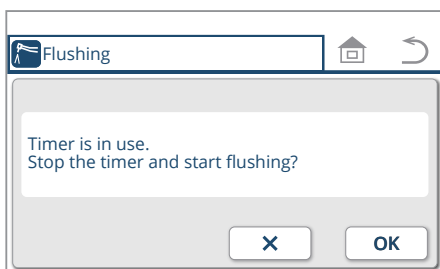

## 6 Setting/Adjustment

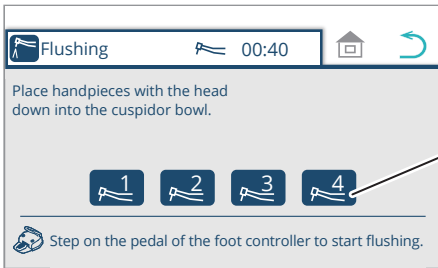

5. Pick up the handpiece you want to flush, and set it in the cuspidor bowl.

The number of the handpiece you have picked up appears. (Handpieces are numbered 1, 2, 3 and 4 from front left.)

The screen does not return to the Home screen even when the  switch is pressed.

Always flush the handpiece with the main body of the ultrasonic scaler attached. Flushing without it may cause a malfunction.

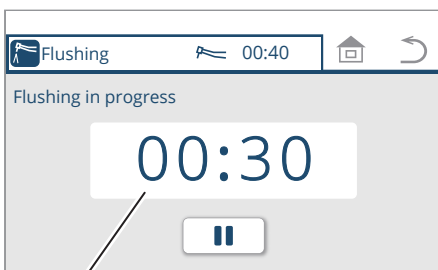



Remaining time (e.g. 30 sec.)



6. Step on the pedal of the foot controller.

When the pedal is released, the handpiece continuously discharges water for 40 seconds.

The screen does not return to the previous screen even when the  switch is pressed.

\* To suspend flushing, press the  switch on the touch panel, the membrane switch, or either switch on the assistant panel, or step on the foot controller pedal.

\* To resume flushing, press the  switch.

\* To terminate flushing prematurely after pressing , press  /membrane switch/assistant operation panel switch, or step on the foot controller.

\* To terminate flushing prematurely without pressing , press the membrane switch/assistant operation panel switch, or step on the foot controller.

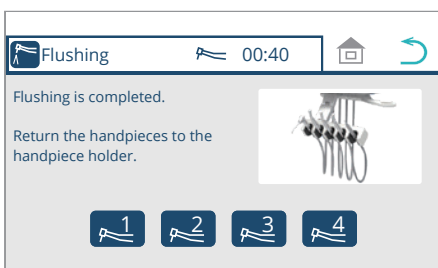
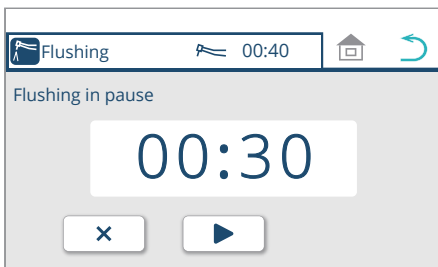

7. Once flushing is completed, return the handpiece to the instrument holder.

When the handpiece is returned, the home screen appears.

Water is not automatically discharged from the syringe. Press the W lever/button for 40 seconds to discharge.

## 6 Setting/Adjustment

Flushing the water circuits of the handpiece and the cupfiller/cuspidor bowl

\* Place a cup on the cupfiller base

1. Press the function switch .

The Function setting screen appears.

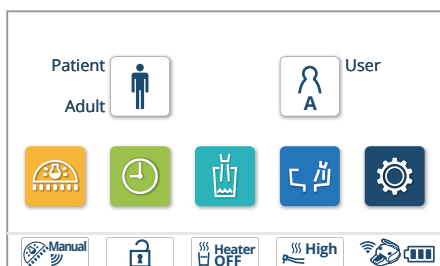

2. Press the 'Flushing, Washing the vacuum line' switch.

If the washing function for vacuum line is not equipped, 'Flushing' appears on the screen instead. Procedures shown below are not applicable.

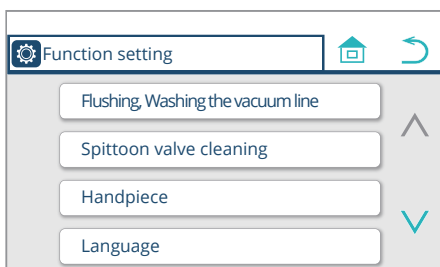

3. Press the 'Flushing' switch.

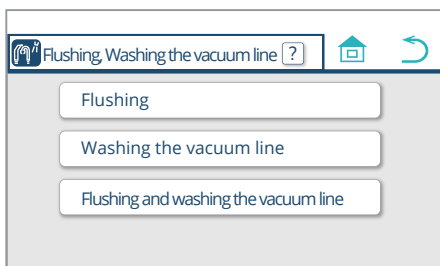

4. Check that 'Long mode 10:00' is selected, and press .

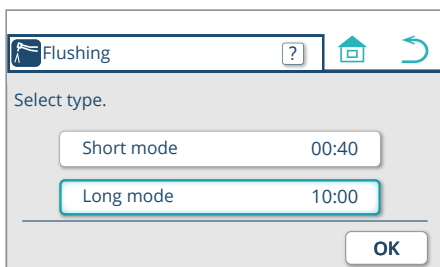

\* When using the timer, the screen shown in the figure on the left is displayed.

Press  to cancel flushing.

Press  to start flushing.

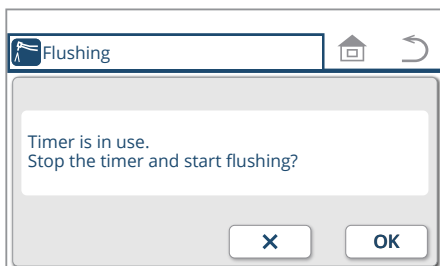

## 6 Setting/Adjustment

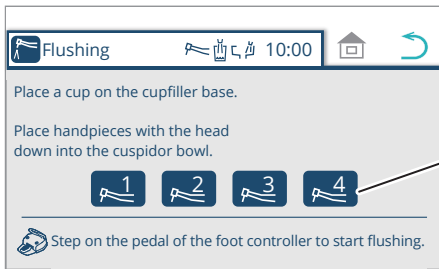

5. Pick up the handpiece you want to flush, and set it in the cuspidor bowl.

The number of the handpiece you picked up appears. (Handpieces are numbered 1, 2, 3 and 4 from front left.)

The screen does not return to the Home screen even when the switch is pressed.

Before starting flushing, always place a cup on the cupfiller base. Without a cup, water will splash onto the wall or chair.

Always flush the handpiece with the main body of the ultrasonic scaler attached. Flushing without it may cause a malfunction.

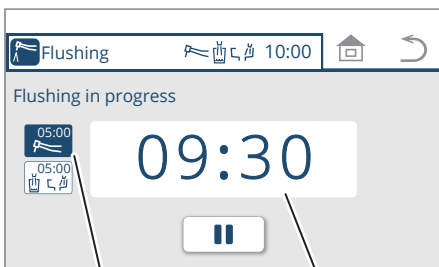

Status of handpiece flushing

Remaining time (e.g. 9 min. 30 sec.)

6. Step on the pedal of the foot controller.

When the pedal is released, the handpieces continuously discharge water for 5 minutes. Then the cupfiller nozzle and bowl flush nozzle discharge water for 5 minutes.

The screen does not return to the previous screen even when the switch is pressed.

\* To suspend flushing, press the switch on the touch panel, the membrane switch, or either switch on the assistant panel, or step on the foot controller pedal.

\* To resume flushing, press .

\* To terminate flushing prematurely after pressing press /membrane switch/assistant operation panel switch, or step on the foot controller.

\* To terminate flushing prematurely without pressing , press the membrane switch/assistant operation panel switch, or step on the foot controller.

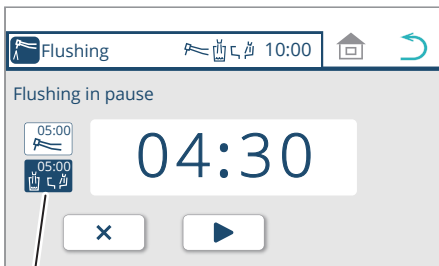

Cupfiller and bowl flush status

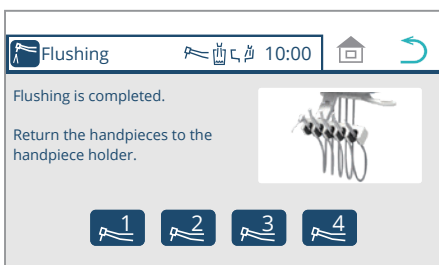

7. Once flushing is completed, return the handpiece to the instrument holder.

When the handpiece is returned, the home screen appears.

Water is not automatically discharged from the syringe. Press the W lever/button for 40 seconds to discharge.

## 6 Setting/Adjustment

### Vac Pac Unit type

#### To flush the water circuit of the handpiece alone (Short mode)

1. Press the function switch  .  
The Function setting screen appears.

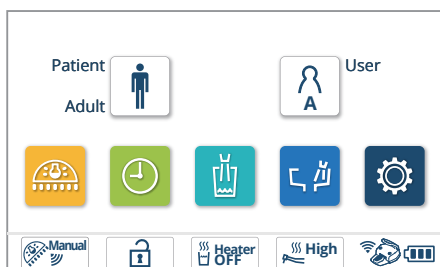

2. Press the 'Flushing, Washing the vacuum line' switch.

If the washing function for vacuum line is not equipped, 'Flushing' appears on the screen instead.  
Procedures shown below are not applicable.

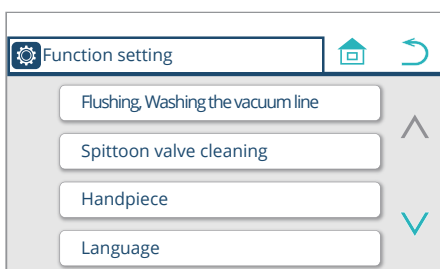

3. Press the 'Flushing' switch.

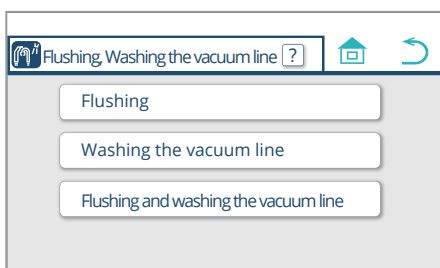

4. Check that 'Short mode 00:40' is selected, and press  .

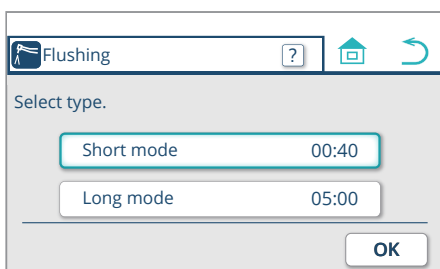

\* When using the timer, the screen shown in the figure on the left is displayed.

Press  to cancel flushing.

Press  to start flushing.

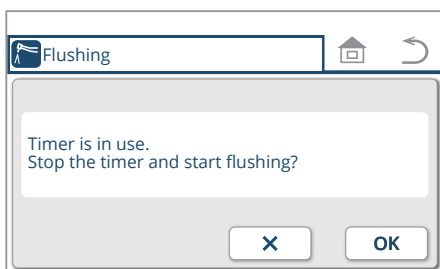

## 6 Setting/Adjustment

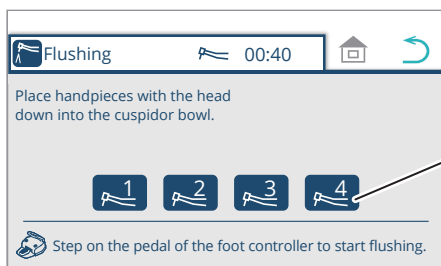

5. Pick up the handpiece you want to flush, and set it in the container, such as a bucket.

The number of the handpiece you have picked up appears. (Handpieces are numbered 1, 2, 3 and 4 from front left.)

The screen does not return to the Home screen even when the  switch is pressed.

Always flush the handpiece with the main body of the ultrasonic scaler attached. Flushing without it may cause a malfunction.

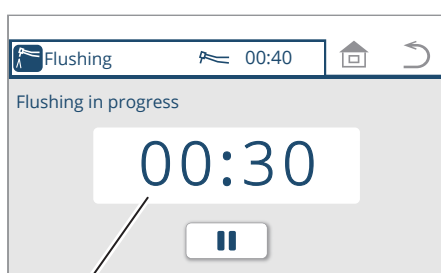

Remaining time (e.g. 30 sec.)



6. Step on the pedal of the foot controller.

When the pedal is released, the handpiece continuously discharges water for 40 seconds.

The screen does not return to the previous screen even when the  switch is pressed.

\* To suspend flushing, press the  switch on the touch panel, the membrane switch, or either switch on the assistant panel, or step on the foot controller pedal.

\* To resume flushing, press the  switch.

\* To terminate flushing prematurely after pressing , press  /membrane switch/assistant operation panel switch, or step on the foot controller.

\* To terminate flushing prematurely without pressing , press the membrane switch/assistant operation panel switch, or step on the foot controller.

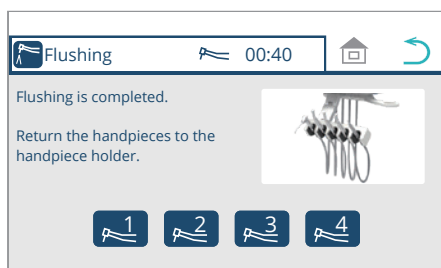
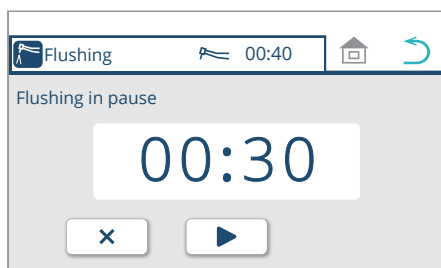

7. Once flushing is completed, return the handpiece to the instrument holder.

When the handpiece is returned, the home screen appears.

Water is not automatically discharged from the syringe. Press the W lever/button for 40 seconds to discharge.



## 6 Setting/Adjustment

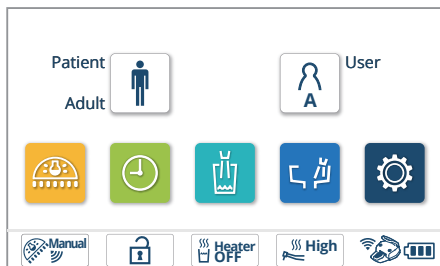

### To flush the water circuit of the handpiece alone (Long mode)

1. Press the function switch  .  
The Function setting screen appears.

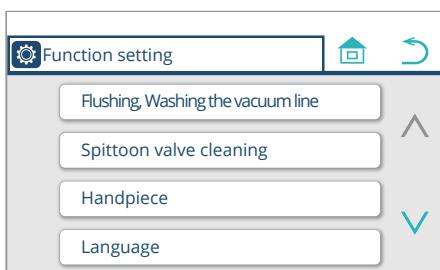

2. Press the 'Flushing, Washing the vacuum line' switch.

If the washing function for vacuum line is not equipped, 'Flushing' appears on the screen instead.  
Procedures shown below are not applicable.

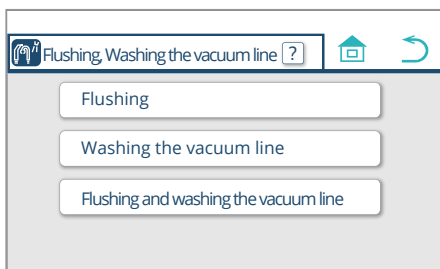

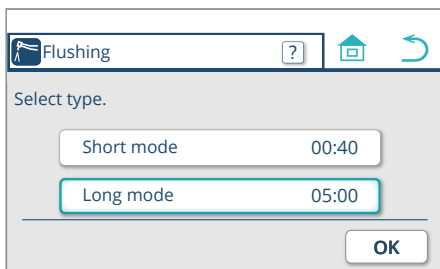

3. Press the 'Flushing' switch.

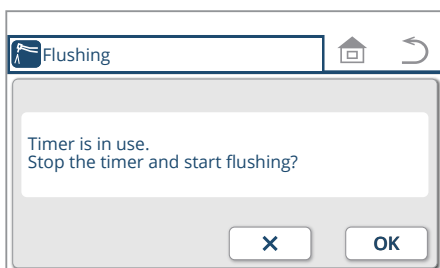

4. Check that 'Long mode 05:00' is selected, and press  .



\* When using the timer, the screen shown in the figure on the left is displayed.  
Press  to cancel flushing.  
Press  to start flushing.

## 6 Setting/Adjustment

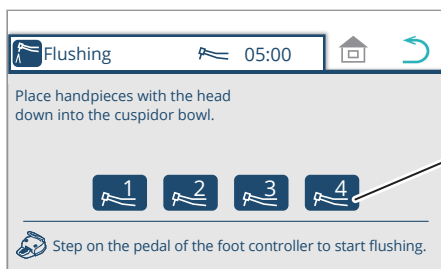

5. Pick up the handpiece you want to flush, and set it in the container, such as a bucket.

The number of the handpiece you have picked up appears. (Handpieces are numbered 1, 2, 3 and 4 from front left.)

The screen does not return to the Home screen even when the  switch is pressed.

Always flush the handpiece with the main body of the ultrasonic scaler attached. Flushing without it may cause a malfunction.

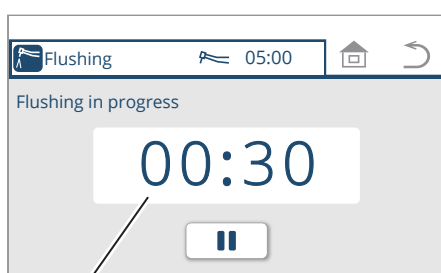

Remaining time (e.g. 30 sec.)



6. Step on the pedal of the foot controller.

When the pedal is released, the handpiece continuously discharges water for 5 minutes.

The screen does not return to the previous screen even when the  switch is pressed.

\* To suspend flushing, press the  switch on the touch panel, the membrane switch, or either switch on the assistant panel, or step on the foot controller pedal.

\* To resume flushing, press the  switch.

\* To terminate flushing prematurely after pressing , press  /membrane switch/assistant operation panel switch, or step on the foot controller.

\* To terminate flushing prematurely without pressing , press the membrane switch/assistant operation panel switch, or step on the foot controller.

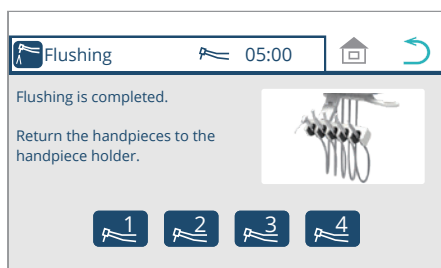
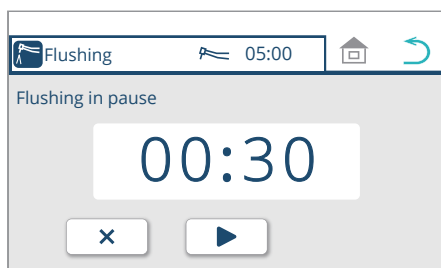

7. Once flushing is completed, return the handpiece to the instrument holder.

When the handpiece is returned, the home screen appears.

Water is not automatically discharged from the syringe. Press the W lever/button for 40 seconds to discharge.

## Preparing handpieces/syringe for flushing

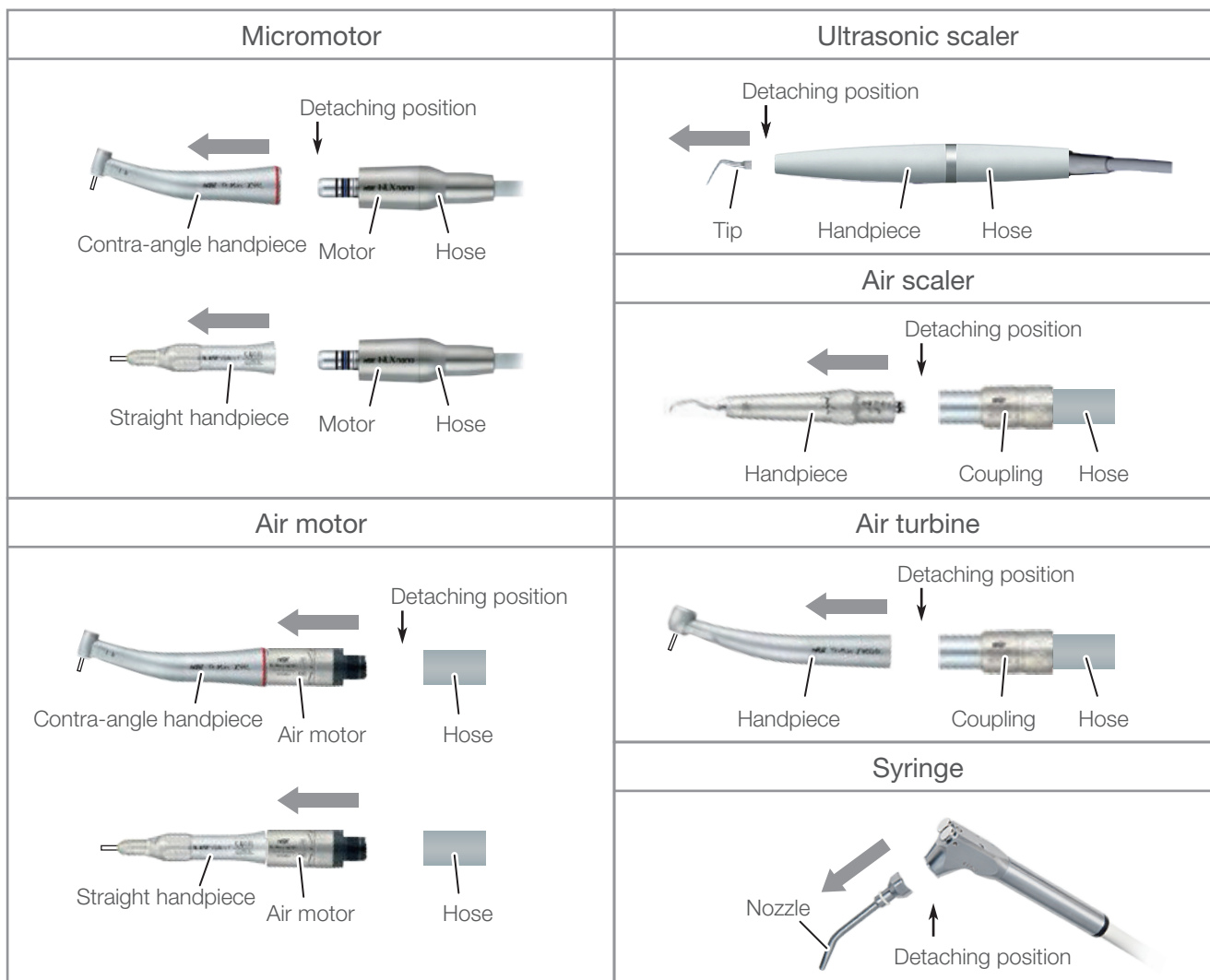

After flushing, wipe the handpiece with a soft cloth to remove excess moisture.

When picking up the handpiece after flushing, remaining air may be discharged. This is normal.

### 6-2-3 Selecting the vacuum line washing method and conducting washing

#### Washing the vacuum line only

The following three options are available: Rinse the vacuum line+wash the vacuum line with cleaner (refer to page 158), Rinse the vacuum line (refer to page 161) , and Wash the vacuum line with cleaner (refer to page 163).

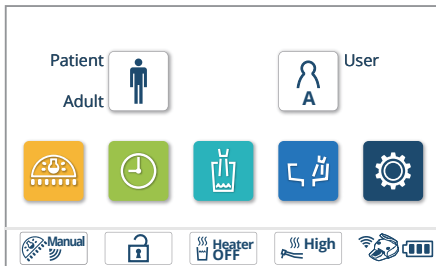

1. Press the function switch  .  
The Function setting screen appears.

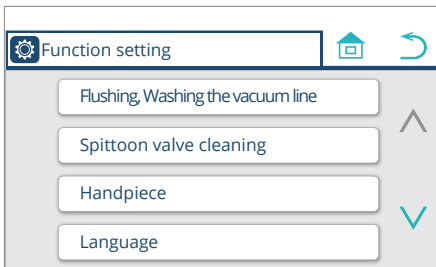

2. Press the 'Flushing, Washing the vacuum line' switch.

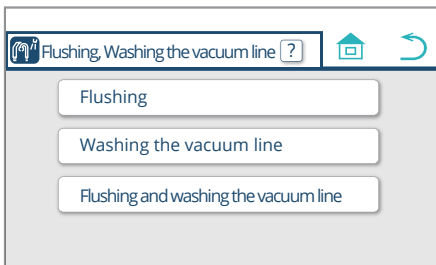

3. Press the 'Washing the vacuum line' switch.

\* To display the explanation of flushing and washing the vacuum line, press the  switch (refer to page 157).

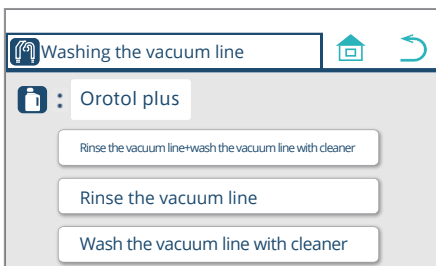

\* If you select 'Washing the vacuum line', the amount of remaining cleaner will be checked. If the amount of cleaner is sufficient, the screen shown in the left figure appears.

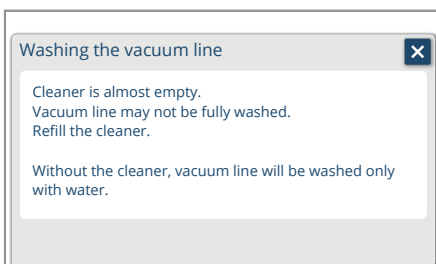

If the amount of cleaner is insufficient, the screen shown in the left figure appears. Refill the cleaner.

[Reference] How to refill the cleaner [pages 172]

After refilling the cleaner, press the  switch to display the 'Washing the vacuum line' screen.

## 6 Setting/Adjustment

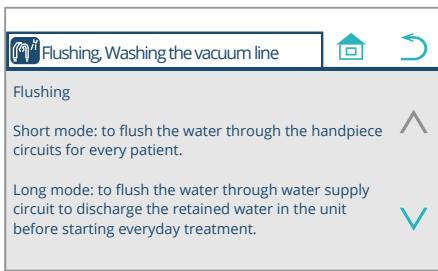

Explanation of flushing and washing the vacuum line

1. Press the **✓** switch.

The display moves to screen 2.

The screen provides an explanation about washing the vacuum line; "Rinse and wash the vacuum line with cleaner", and "Rinsing".

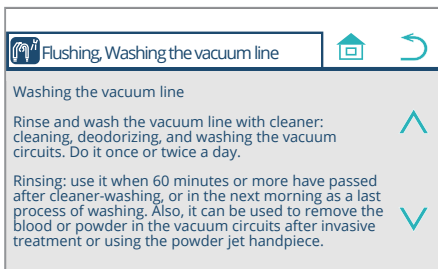

2. Press the **✓** switch.

The display moves to screen 3.

The screen provides an explanation about washing the vacuum line; "Washing with cleaner" and "Flushing and washing the vacuum line".

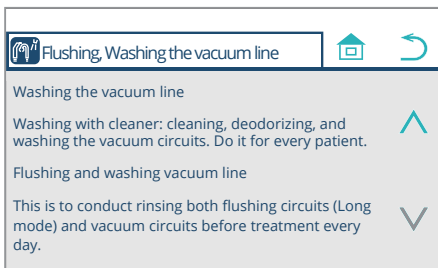

3. Press the **^** switch.

The display returns to screen 2.

The screen provides an explanation about washing the vacuum line; "Rinse and wash the vacuum line with cleaner", and "Rinsing".

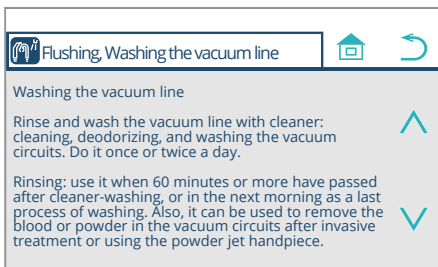

4. Press the **^** switch.

The display returns to screen 1.

The screen provides an explanation about flushing: Short mode and Long mode.

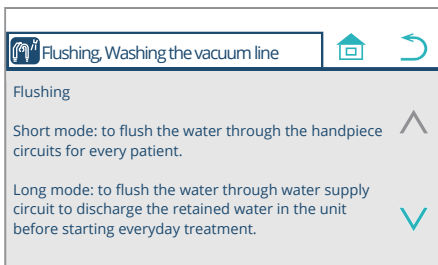

5. Press the **↺** switch.

The display returns to screen 3 shown on page 156.

## Rinsing the vacuum line+washing the vacuum line with cleaner

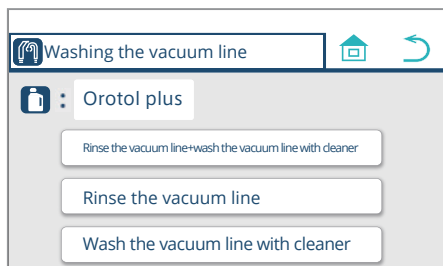

1. Press the 'Rinse the vacuum line+wash the vacuum line with cleaner' switch.

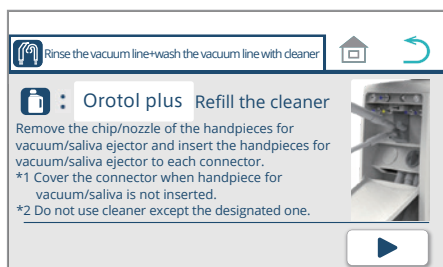

\* If the amount of cleaner is insufficient, the screen shown in the left figure appears. Refill the cleaner.  
[Reference] How to refill the cleaner [pages 172]

2. Start rinsing the vacuum line+washing the vacuum line with cleaner.

① Open the maintenance panel cover (top) of the cuspidor unit. Pick up the vacuum and saliva ejector handpieces from the assistant holder and insert them into the connector.  
[Reference] Procedure for washing with cleaner [page 171]  
(At this time, the suction is not activated.)

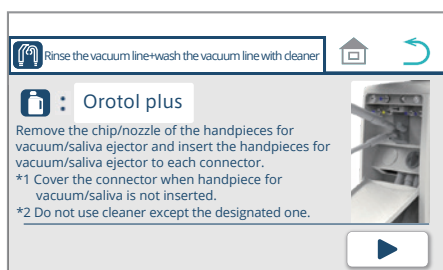

② Press the  switch.

\* Before pressing the  switch, make sure to insert the vacuum and saliva ejector handpieces into the connector.

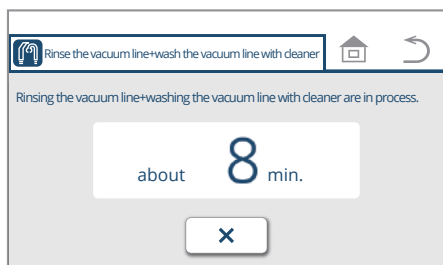

The screen does not return to the home screen even when the  switch is pressed.

\* To stop washing the vacuum line in progress, press the  switch.

## 6 Setting/Adjustment

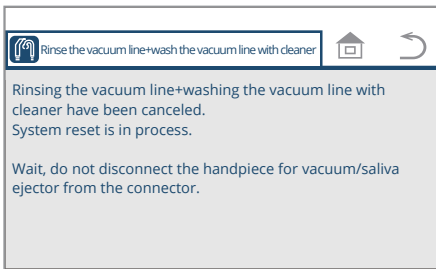

\* If the  switch is pressed during washing, the screen shown in the left figure appears.

If the handpiece is removed from the connector while the screen on the left is displayed, the cleaner will be left inside the handpiece and handpiece hose. Leaving the cleaner standing may cause a bacterial growth.

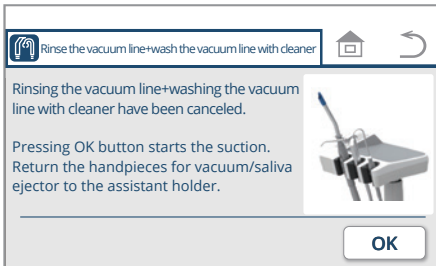

Press the  switch.

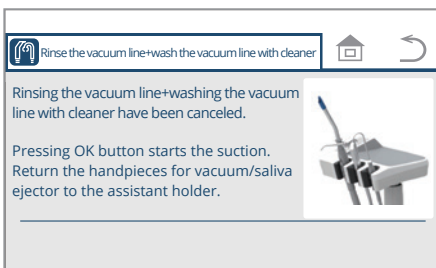

\* After the suction starts, return the vacuum and saliva ejector handpieces to the assistant holder.  
When the vacuum and saliva ejector handpieces are returned to the assistant holder, the screen returns to the home screen.

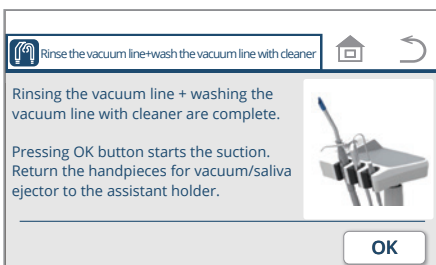

3. When you have finished rinsing the vacuum line+washing the vacuum line with cleaner, press the  switch.

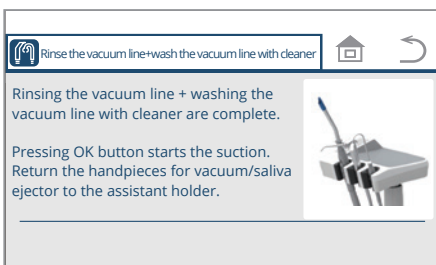

\* After the suction starts, return the vacuum and saliva ejector handpieces to the assistant holder.  
When the vacuum and saliva ejector handpieces are returned to the assistant holder, the screen returns to the home screen.

After the suction starts, remove the vacuum and saliva ejector handpieces from the connector.  
Dripping of the cleaner can be prevented.  
If the cleaner drips from the connector, wipe it off immediately.  
Places where the cleaner adheres may become discolored.

## 6 Setting/Adjustment

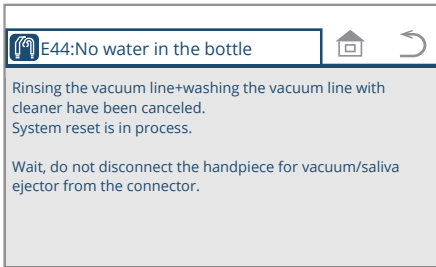

e.g.

E44: No water in the bottle

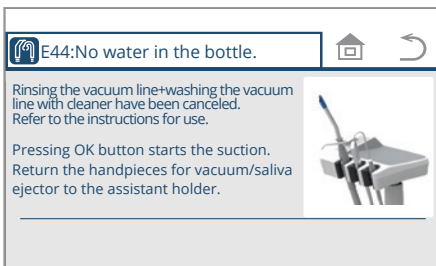
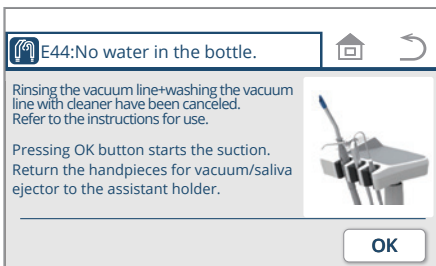

4. In the event of an error state, take appropriate measures. In the event of an error state before/upon/during washing with cleaner/rinsing, the system will be reset and the error screen will appear.

“Message on the touch panel and measures to be taken”

Refer to pages 218 to 220 and take measures in accordance with the remedies given.

5. Press the  switch.

\* After the suction starts, return the vacuum and saliva ejector handpieces to the assistant holder.

When the vacuum and saliva ejector handpieces are returned to the assistant holder, the screen returns to the home screen.



## Rinsing the vacuum line

1. Press the 'Rinse the vacuum line' switch.

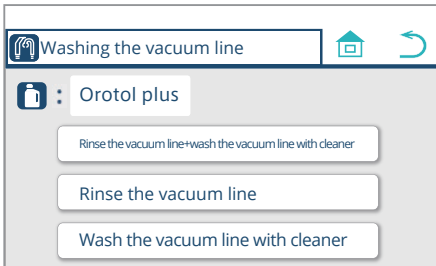



2. Start rinsing the vacuum line.

① Open the maintenance panel cover (top) of the cuspidor unit. Pick up the vacuum and saliva ejector handpieces from the assistant holder and insert them into the connector.

[Reference] Procedure for washing with cleaner [page 171]

② Press the  switch.

\* Before pressing the  switch, make sure to insert the vacuum and saliva ejector handpieces into the connector.

The screen does not return to the home screen even when the  switch is pressed.

\* To stop washing the vacuum line in progress, press the  switch.

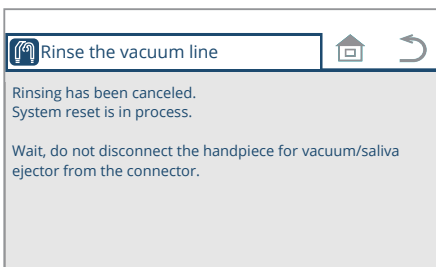
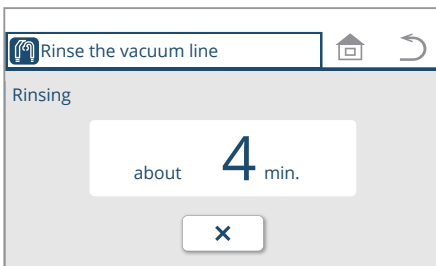
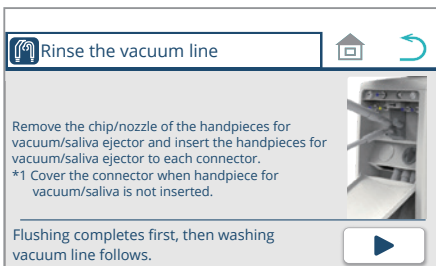

\* If the  switch is pressed during washing, the screen shown in the left figure appears.

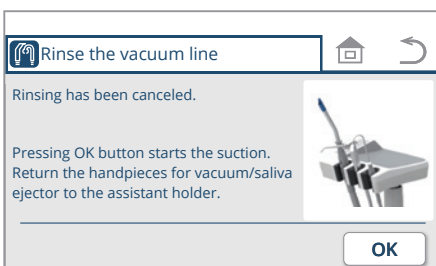

Press the  switch.

\* After the suction starts, return the vacuum and saliva ejector handpieces to the assistant holder.

When the vacuum and saliva ejector handpieces are returned to the assistant holder, the screen returns to the home screen.

## 6 Setting/Adjustment

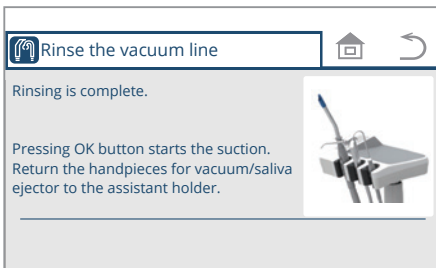
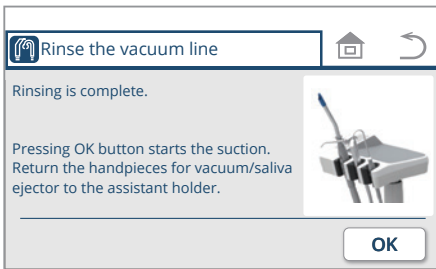

3. After rinsing of the vacuum line is completed, press the **OK** switch.

\* After the suction starts, return the vacuum and saliva ejector handpieces to the assistant holder. When the vacuum and saliva ejector handpieces are returned to the assistant holder, the screen returns to the home screen.

After the suction starts, remove the vacuum and saliva ejector handpieces from the connector. Dripping of the cleaner can be prevented. If the cleaner drips from the connector, wipe it off immediately. Places where the cleaner adheres may become discolored.

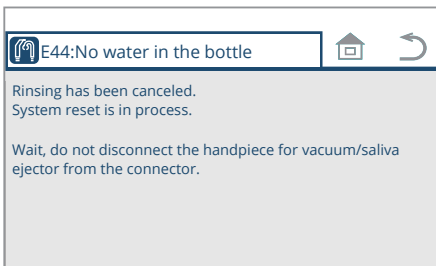

e.g.

E44: No water in the bottle

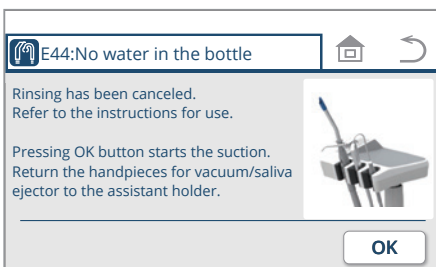

5. Press the **OK** switch.

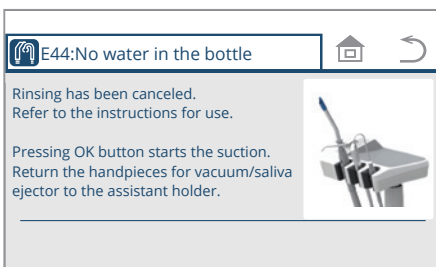

\* After the suction starts, return the vacuum and saliva ejector handpieces to the assistant holder. When the vacuum and saliva ejector handpieces are returned to the assistant holder, the screen returns to the home screen.

## Washing the vacuum line with cleaner

1. Press the 'Wash the vacuum line with cleaner' switch.

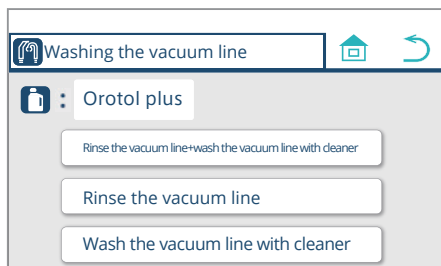

\* If the amount of cleaner is insufficient, the screen shown in the left figure appears. Refill the cleaner.  
[Reference] How to refill the cleaner [pages 172]

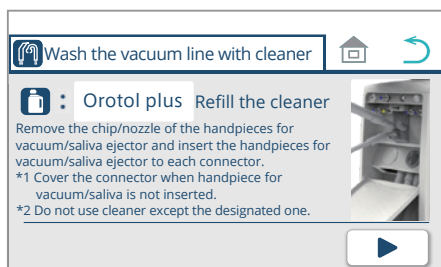



2. Start washing the vacuum line with cleaner.

① Open the maintenance panel cover (top) of the cuspidor unit. Pick up the vacuum and saliva ejector handpieces from the assistant holder and insert them into the connector.  
[Reference] Procedure for washing with cleaner [page 171]  
(At this time, the suction is not activated.)

② Press the  switch.

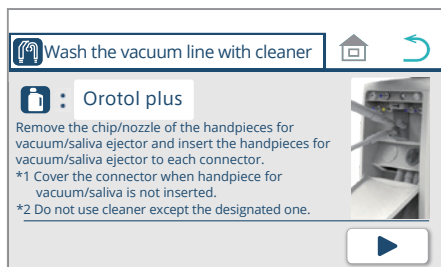
\* Before pressing the  switch, make sure to insert the vacuum and saliva ejector handpieces into the connector.



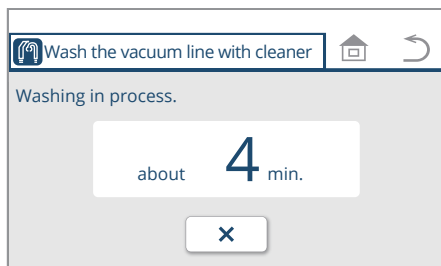

The screen does not return to the home screen even when the  switch is pressed.

\* To stop washing the vacuum line in progress, press the  switch.

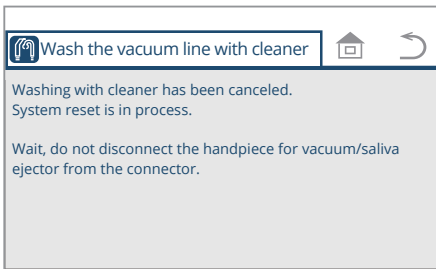

## 6 Setting/Adjustment



\* If the  switch is pressed during washing, the screen shown in the left figure appears.

If the handpiece is removed from the connector while the screen on the left is displayed, the cleaner will be left inside the handpiece and handpiece hose. Leaving the cleaner standing may cause a bacterial growth.

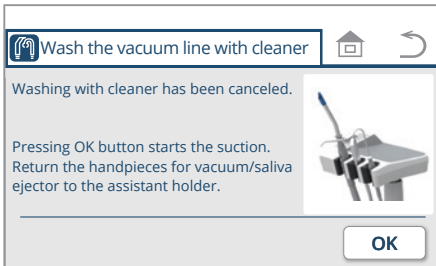

Press the  switch.

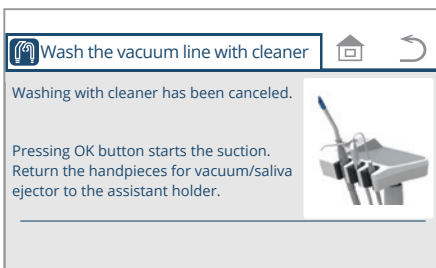

\* After the suction starts, return the vacuum and saliva ejector handpieces to the assistant holder. When the vacuum and saliva ejector handpieces are returned to the assistant holder, the screen returns to the home screen.

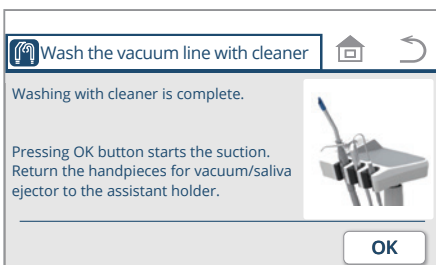

3. When you have finished washing the vacuum line with cleaner, press the  switch.

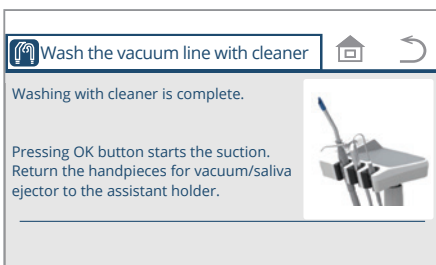

\* After the suction starts, return the vacuum and saliva ejector handpieces to the assistant holder. When the vacuum and saliva ejector handpieces are returned to the assistant holder, the screen returns to the home screen.

After the suction starts, remove the vacuum and saliva ejector handpieces from the connector. Dripping of the cleaner can be prevented. If the cleaner drips from the connector, wipe it off immediately. Places where the cleaner adheres may become discolored.

## 6 Setting/Adjustment

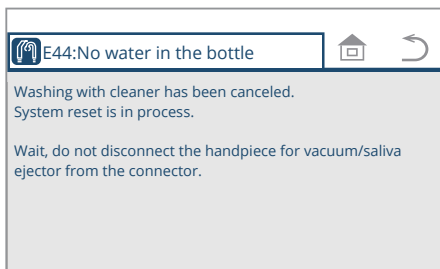

e.g.

E44: No water in the bottle

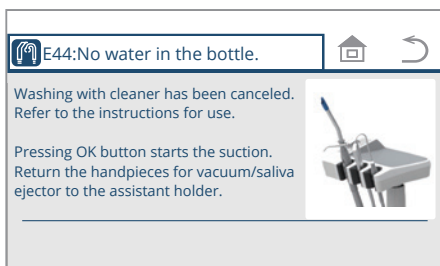
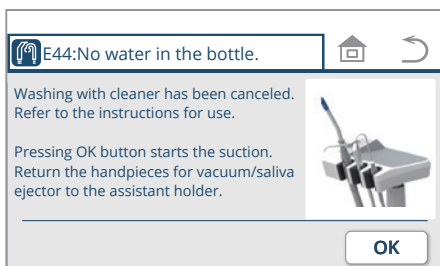

4. In the event of an error state, take appropriate measures.

In the event of an error state before/upon/during washing with cleaner/rinsing, the system will be reset and the error screen will appear.

“Message on the touch panel and measures to be taken”

Refer to pages 218 to 220 and take measures in accordance with the remedies given.

5. Press the  switch.

\* After the suction starts, return the vacuum and saliva ejector handpieces to the assistant holder.

When the vacuum and saliva ejector handpieces are returned to the assistant holder, the screen returns to the home screen.

## Flushing and rinsing the vacuum line



1. Press the function switch .  
The Function setting screen appears.

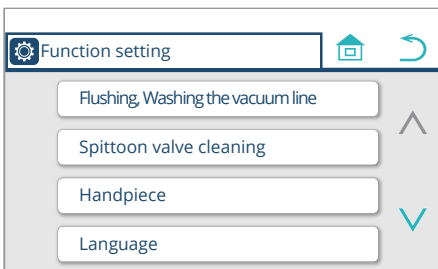

2. Press the 'Flushing, Washing the vacuum line' switch.

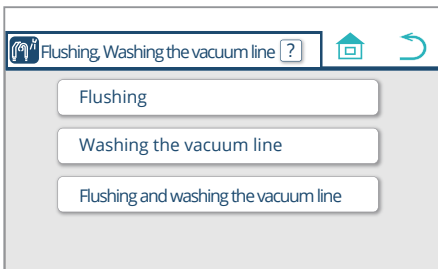

3. Press the 'Flushing and washing the vacuum line' switch.

\* To display the explanation of flushing and washing the vacuum line, press the switch (refer to page 157).

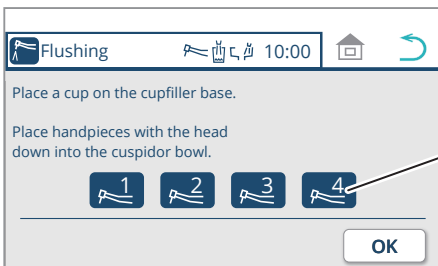

4. Pick up the handpiece you want to flush, and set it in the cuspidor bowl.

The number of the handpiece you have picked up appears. (Handpieces are numbered 1, 2, 3 and 4 from front left.)

The screen does not return to the Home screen even when the switch is pressed.

Always flush the handpiece with the main body of the ultrasonic scaler attached. Flushing without it may cause a malfunction.

5. Press the switch.

## 6 Setting/Adjustment

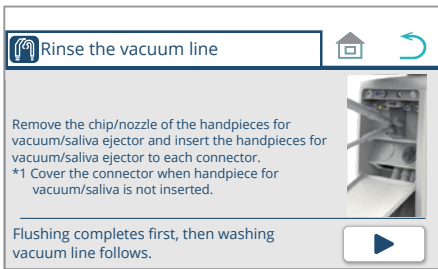

6. Open the front panel of the cuspidor unit. Pick up the vacuum and saliva ejector handpieces from the assistant holder and insert them into the connector.

Press the  switch.

Flushing and rinsing of the vacuum line will start.

\* Before pressing the  switch, make sure to insert the vacuum and saliva ejector handpieces into the connector.

The screen does not return to the home screen even when the  switch is pressed.

Water flows out of the handpiece for five minutes.

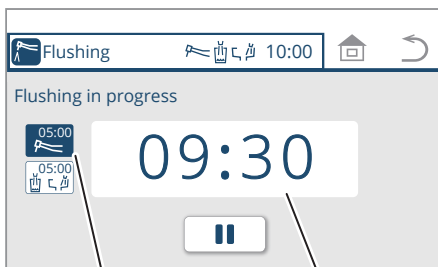

Then, water flows out of the cupfiller nozzle and the bowl flush nozzle for five minutes.





Status of handpiece flushing

Remaining time (e.g. 9 min. 30 sec.)



If the cuspidor bowl is not equipped, rinsing the vacuum line starts 5 minutes after flushing the water circuits of handpieces.

If you need to start rinsing the vacuum line immediately after flushing the water circuits of handpieces, press  then press . Rinsing the vacuum line starts. [Refer to page 161]

The screen does not return to the previous screen even when the  switch is pressed.

\* To suspend flushing, press the  switch on the touch panel, the membrane switch, or either switch on the assistant panel, or step on the foot controller pedal.

\* To resume flushing, press the  switch.

\* To terminate flushing prematurely after pressing , press  /membrane switch/assistant operation panel switch, or step on the foot controller.

\* To terminate flushing prematurely without pressing , press the membrane switch/assistant operation panel switch, or step on the foot controller.

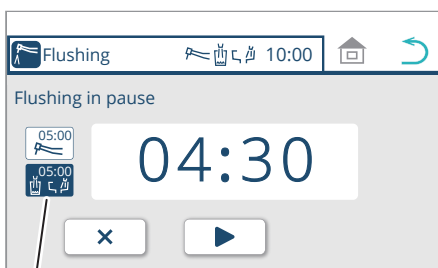

Cupfiller and bowl flush status

## 6 Setting/Adjustment

To display the screen in step 6, press the  switch.

To display the screen shown in the left figure, press the  switch.

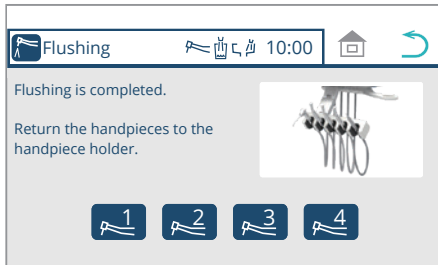

When flushing is completed, rinsing of the vacuum line will start.

\* To stop rinsing the vacuum line in progress, press the  switch.

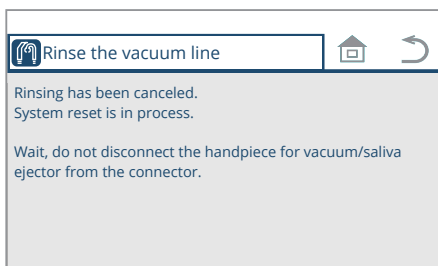
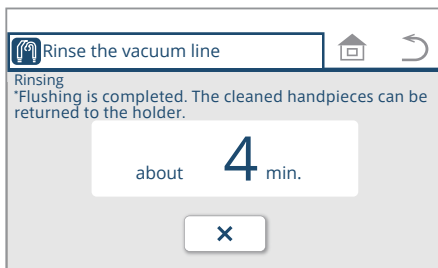

\* If the  switch is pressed during rinsing, the screen shown in the left figure appears.

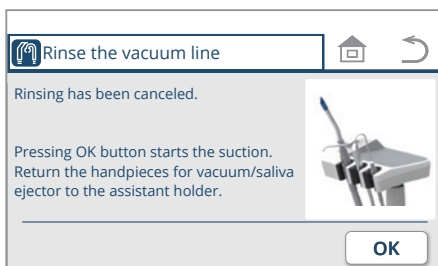
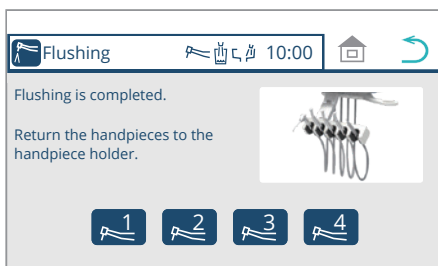

Press the  switch.

\* After the suction starts, return the vacuum and saliva ejector handpieces to the assistant holder. When the vacuum and saliva ejector handpieces are returned to the assistant holder, the screen returns to the home screen.



## 6 Setting/Adjustment

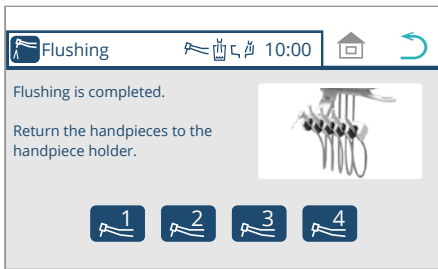

7. After rinsing of the vacuum line is completed, return the handpieces for doctor unit to the instrument holder.

After flushing, if the handpieces are returned to the instrument holder while the vacuum line is being rinsed, the screen shown in the left figure does not appear.

\* Water is not automatically discharged from the syringe. Press the W lever/button of the syringe for 40 seconds to discharge.

To display the screen shown in the left figure, press the  switch.

Press the  switch.

The screen in step 6 appears.

To display the screen in step 3, press the  switch.

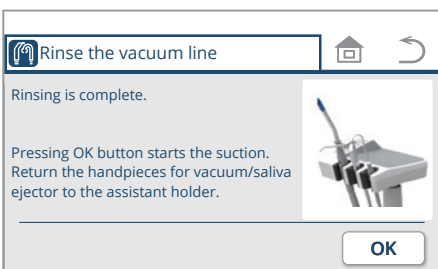
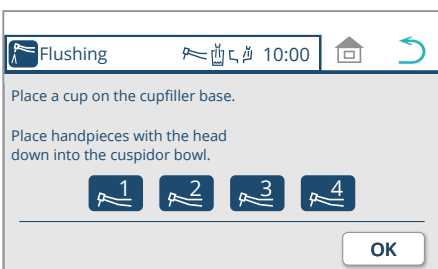

8. Press the  switch.

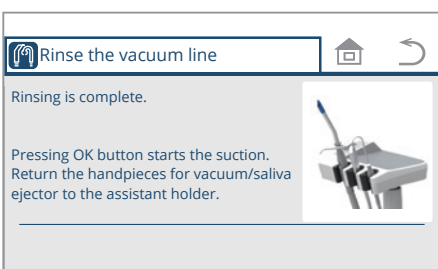

\* After the suction starts, return the vacuum and saliva ejector handpieces to the assistant holder.

When the vacuum and saliva ejector handpieces are returned to the assistant holder, the screen returns to the home screen.

\* If the handpieces for doctor unit are returned after the vacuum and saliva ejector handpieces, the home screen appears instead of the screen in step 8.

After the suction starts, remove the vacuum and saliva ejector handpieces from the connector.

Dripping of the cleaner can be prevented.

If the cleaner drips from the connector, wipe it off immediately.

Places where the cleaner adheres may become discolored.

## 6 Setting/Adjustment

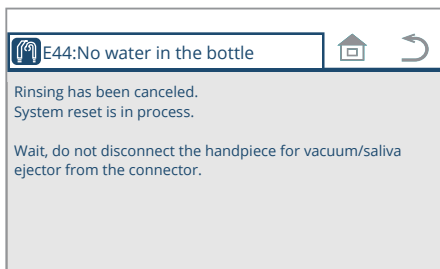

e.g.

E44: No water in the bottle

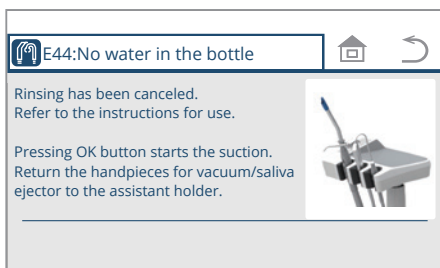
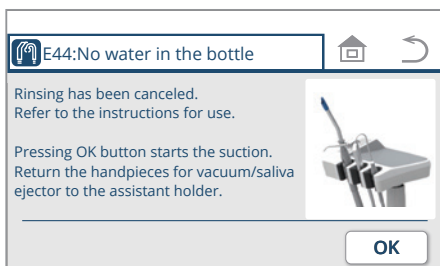

9. In the event of an error state, take appropriate measures.

In the event of an error state before/upon/during washing with cleaner/rinsing, the system will be reset and the error screen will appear.

“Message on the touch panel and measures to be taken”

Refer to pages 218 to 220 and take measures in accordance with the remedies given.

10. Press the  switch.

\* After the suction starts, return the vacuum and saliva ejector handpieces to the assistant holder.

When the vacuum and saliva ejector handpieces are returned to the assistant holder, the screen returns to the home screen.

(1)

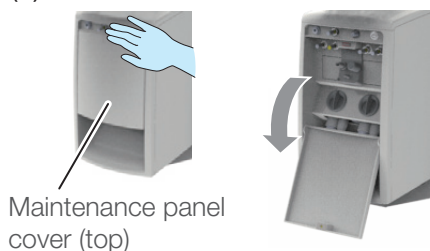

### Procedures for washing with cleaner

(1) Open the maintenance panel cover (top) of the cuspidor unit.

(2) Pick up the vacuum and saliva ejector handpieces from the assistant holder. Remove the vacuum and saliva ejector chips.

(3)

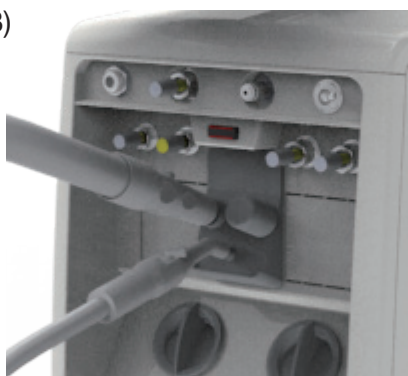

(3) Insert (2) into the connector.

A vacuum connector cap (hereinafter, 'connector cap') should be attached to a connector that is not being used.

Do not remove the connector cap attached to a connector that has no function or a connector that is not being used. Its removal weakens the suction and may hinder suction capacity. The connector cap may be lost when removed.

Solid collector



\* Do not remove the solid collector while washing. Without the solid collector, the suction does not work.

If the solid collector is removed during washing, the washing will not be performed and water may burst forth.

\* Do not remove the handpiece from the connector during washing. An error may occur.

The washing may take longer than the indicated time depending on the vacuum capacity of the machine room.

## 6 Setting/Adjustment

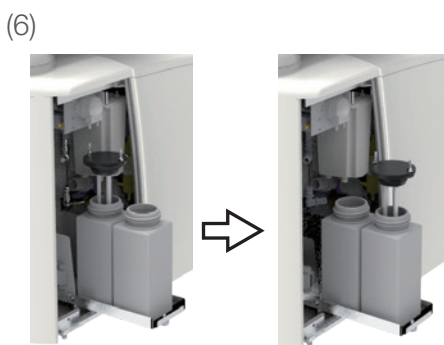
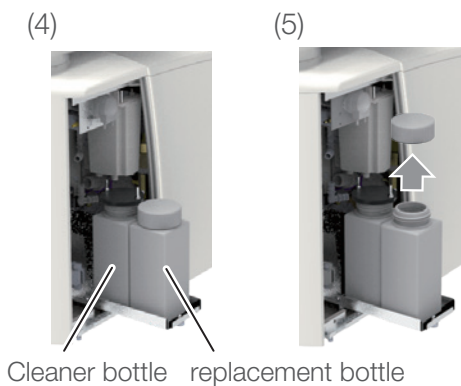
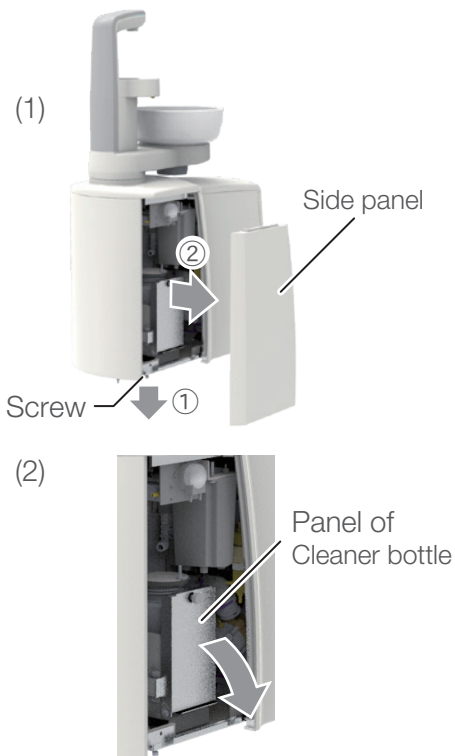

### How to refill the cleaner

- (1) Open the side panel of the cuspidor unit.
  - ① Loosen the screw.
  - ② Pull open the side panel toward you.
- (2) Pull down the cleaner bottle panel toward you.
- (3) Pour up to 500 ml of cleaner into the replacement bottle. Place the cap on the bottle and bring the bottle near the cuspidor unit.
- (4) Move the cleaner bottle toward you.  
Place the cleaner and replacement bottles next to each other.
- (5) Remove the cap from the replacement bottle.
- (6) Remove the cover from the cleaner bottle by lifting it up slowly. Attach the cover to (5).
- (7) Move (6) to the place where the used cleaner bottle was originally located.

Besides the bottle in the cuspidor unit, a replacement bottle with a cap is also attached. Store it in a stock room and use it when replacing the cleaner bottle in the cuspidor unit with a new one.

Do not pour any cleaner except our designated cleaner into the cleaner bottle. The bottle can hold up to 500 ml of cleaner, enough for approximately 25 washes.

Place the cap on the remaining bottle. Use the bottle for replacement. Use the cleaner remaining in the replaced bottle when refilling the cleaner the next time.

### 6-2-4 Displaying the drive air pressure

Display the handpiece drive air pressure.

1. Press the function switch .  
The Function setting screen appears.

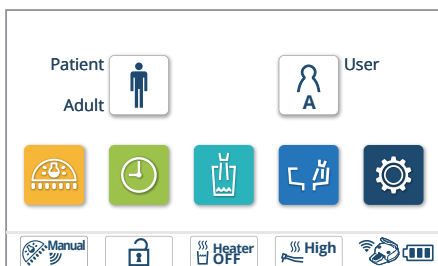

2. Press 'Handpiece.'

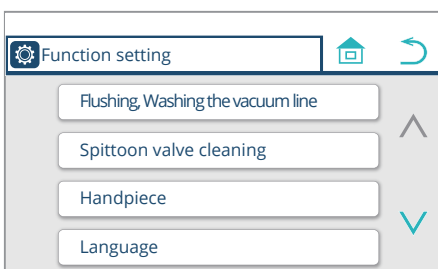



3. Press 'Drive air pressure.'  
The Drive air pressure screen appears.



4. Pick up the handpiece to measure the pressure from the instrument holder.

5. Step on the pedal of the foot controller.  
The air pressure is displayed.

During the pedal of foot controller being stepped on, pressing  will not bring the mode to home screen; pressing  will not bring the mode to the previous screen.

6. After checking the pressure, return the handpiece to the instrument holder.

7. Press the  switch to display the Home screen.

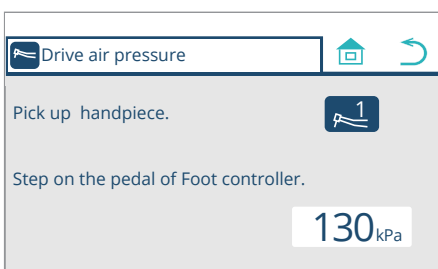



### 6-2-5 Setting the spray mode

Two mode: Spray ON/OFF

Four mode: Air and water ON/OFF

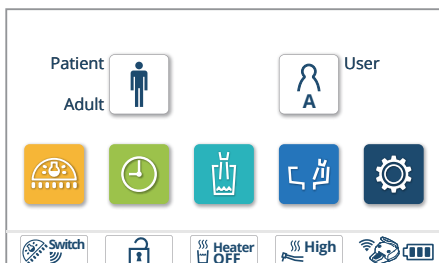
\* The ultrasonic scaler discharges water regardless of whether in two mode or four mode.



1. Press the function switch  .  
The Function setting screen appears.

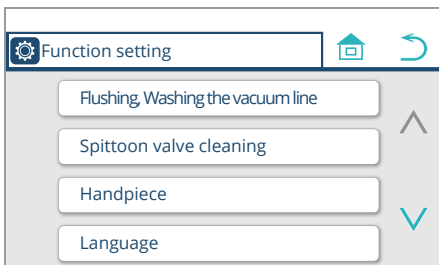

2. Press 'Handpiece.'

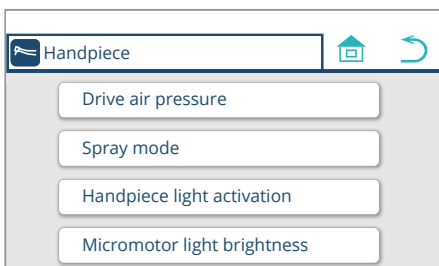

3. Press 'Spray mode.'  
The Spray Mode setting screen appears.

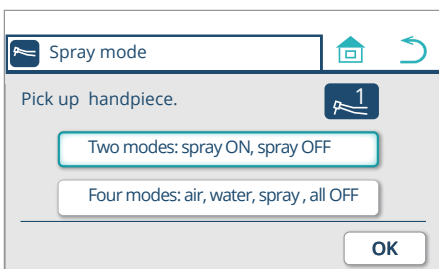

4. Pick up the handpiece you want to set.

5. Select 'Two mode' or 'Four mode.'

6. Press  to save the setting.  
The previous screen appears.

\* To cancel the setting, press  without pressing  .

7. Return the handpiece to the instrument holder.

8. Press the  switch to display the Home screen.

## 6-2-6 Setting the light activation timing

Two types of light activation timing can be selected.

### ‘When picking up a handpiece’

Turns on when the handpiece is picked up from the instrument holder and will turn off when returned to the holder.

\* For NO PAIN, the light turns off after the afterglow period is completed.

### ‘When stepping on the foot controller’

Turns on while the handpiece is activated and off after the after-glow period (approx. 5 seconds) is completed after the handpiece deactivates.

\* For NO PAIN, the light turns off after the afterglow period is completed.

\* Contact your local authorized Belmont dealer when the setting of afterglow period for NEWTRON/ VARIOS170 should be changed.

Setting of afterglow period for NO PAIN cannot be changed.

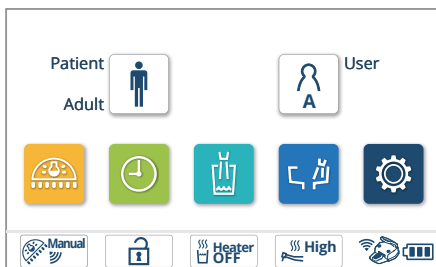

1. Press the function switch .

The Function setting screen appears.

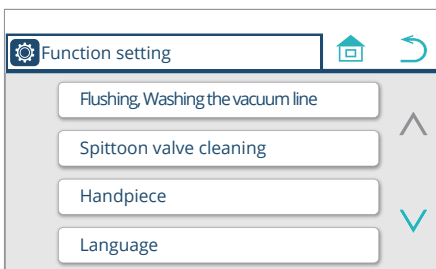

2. Press ‘Handpiece.’

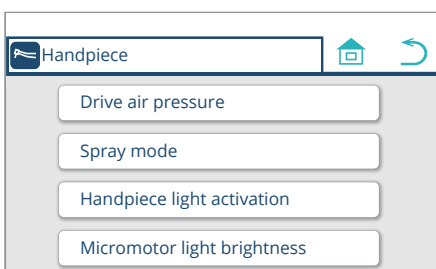

3. Press ‘Handpiece light activation.’

The Handpiece light activation setting screen appears.

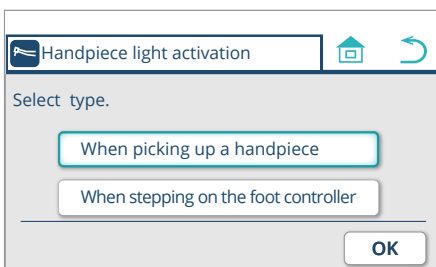

4. Select ‘When picking up a handpiece’ or ‘When stepping on the foot controller.’

5. Press  to save the setting.

The previous screen appears.

\* To cancel the setting, press without pressing .

6. Press the switch to display the Home screen.

## 6-2-7 Setting the micromotor brightness

Handpiece light brightness (illuminance) can be changed.

NLX plus

1. Press the function switch  .  
The Function setting screen appears.

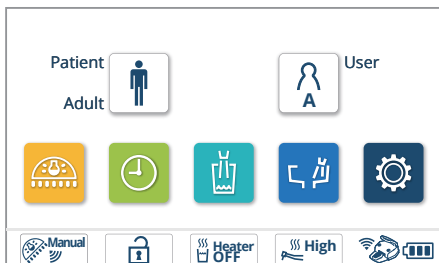

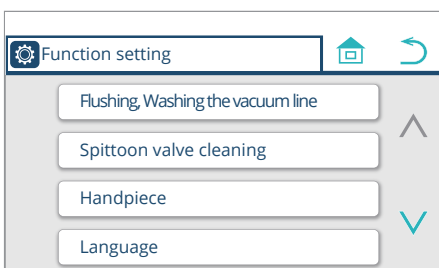

2. Press 'Handpiece.'

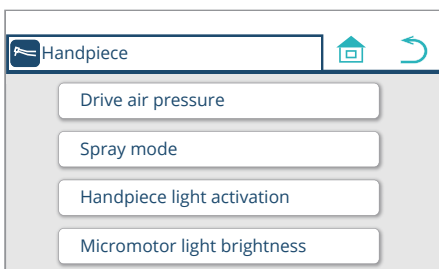

3. Press 'Micromotor light brightness.'
- The micromotor light brightness setting screen appears.



4. Pick up the handpiece to set.

5. Press the   switches to adjust the brightness.  
Adjust the brightness while checking actual brightness.

\* It is not necessary to press  to save this setting.  
It is memorized when the brightness (illuminance) is set.

6. Press the  switch to return to the Home screen.

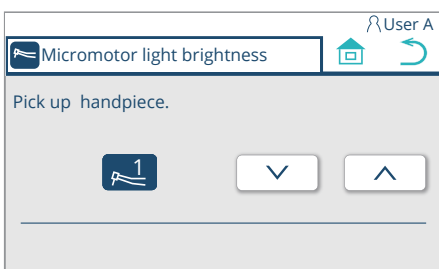



## 6 Setting/Adjustment

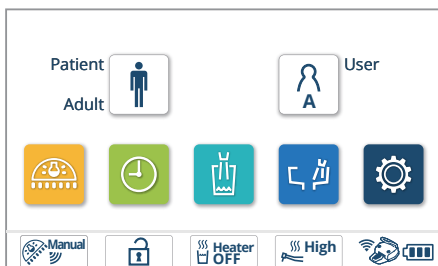

### MX2/MCX

1. Press the function switch .

The Function setting screen appears.

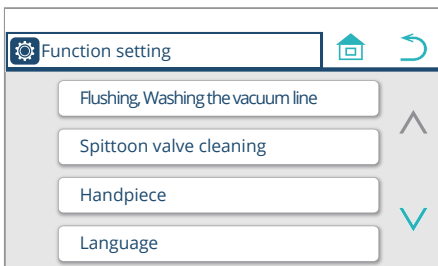

2. Press 'Handpiece.'



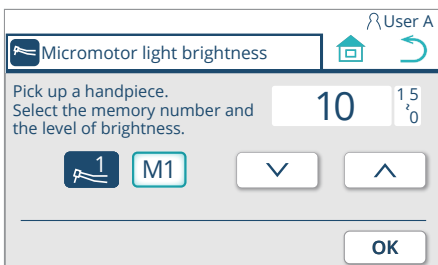

3. Press 'Micromotor light brightness.'

The micromotor light brightness setting screen appears.



4. Pick up the handpiece you want to set.

5. Press the memory switch  to select [M1], [M2], [M3], or [M4]. These four switches appear sequentially every time the [M1] switch is pressed.

6. Press the   switches to adjust the brightness between [0] and [15].

The brightness can be adjusted by [1] increment.

7. Press  to save the setting.

The previous screen appears.

\* To cancel the setting, press  without pressing .

8. Press the  switch to return to the Home screen.

## 6-2-8 Setting the cupfiller water level

The cupfiller water level setting is set on shipment from the factory but may be adjusted as required.

The cupfiller water level and filling duration when using the cupfiller switch (forced cup-filling) can be adjusted.



1. Press the function switch .

The Function setting screen appears.

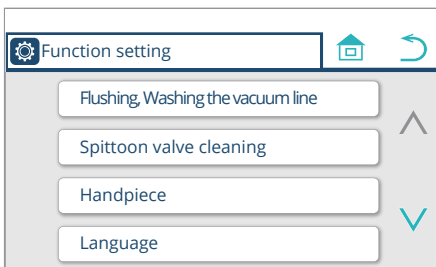

2. Press the switch.

The second page of the Function setting screen appears.

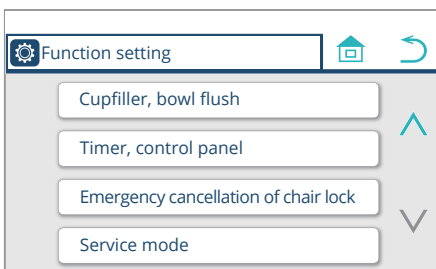

3. Press 'Cupfiller, bowl flush.'

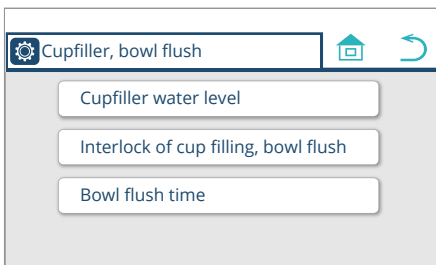

4. Press 'Cupfiller water level.'

The Cupfiller water level setting screen appears.

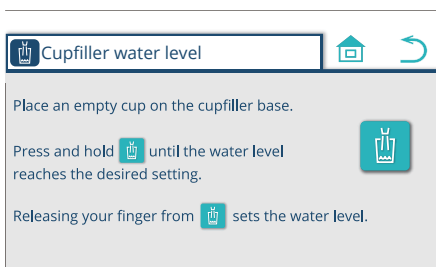

5. Place an empty cup on the cupfiller base, and press and hold the switch to fill the cup to the desired level.

\* Water is supplied while the switch is pressed and stops when it is released.

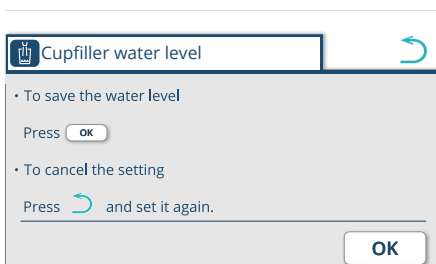



\* To memorize the cupfiller water level, press . After pressing , the previous screen appears.

\* To cancel the setting, press without pressing . After pressing , the previous screen appears.

6. Press the  switch to return to the Home screen.

If the water supplied exceeds the desired water level, set it again from the beginning.

To cancel the setting in the middle, press  or .

## 6-2-9 Setting the cup-filling/bowl flush interlock

The following two modes can be selected:

‘Interlock’

Cuspidor bowl flush starts at the same time as cup-filling.

‘No interlock’

The cuspidor bowl is not flushed even when cup-filling is started.

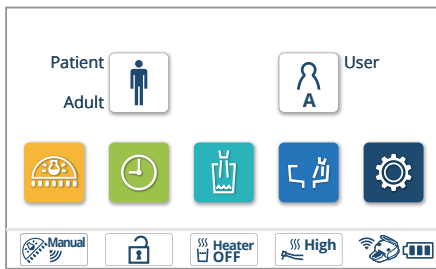

1. Press the function switch  .  
The Function setting screen appears.

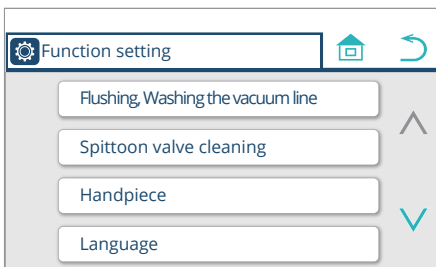

2. Press the  switch.  
The second page of the Function setting screen appears.

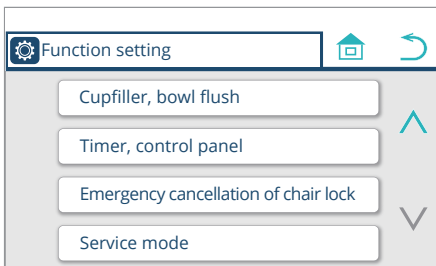

3. Press ‘Cupfiller, bowl flush.’

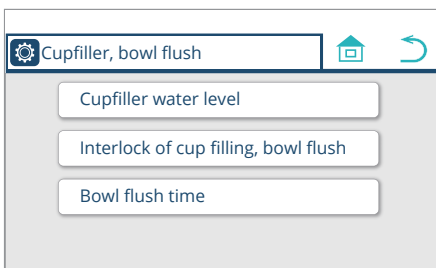

4. Press ‘Interlock of cup filling, bowl flush.’  
The Interlock of cup filling, bowl flush screen appears.

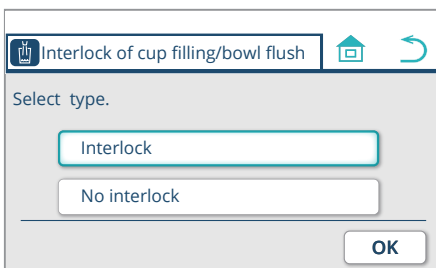

5. Select ‘Interlock’ or ‘No interlock.’

6. Press  to save the setting.  
The previous screen appears.

\* To cancel the setting, press  without pressing  .

7. Press the  switch to return to the Home screen.

## 6 Setting/Adjustment

### 6-2-10 Setting the bowl flush time

Duration of the bowl flush can be set.

1. Press the function switch .  
The Function setting screen appears.

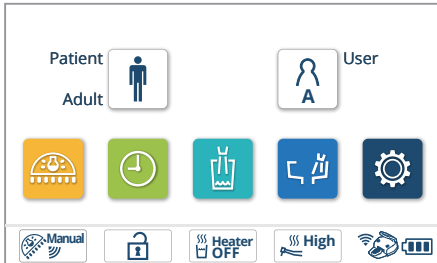

2. Press the  switch.  
The second page of the Function setting screen appears.

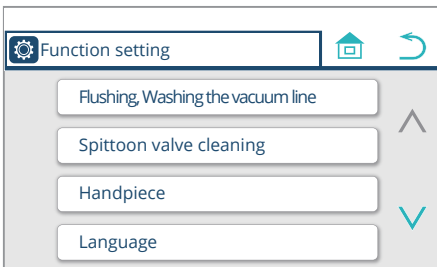

3. Press 'Cupfiller, bowl flush.'

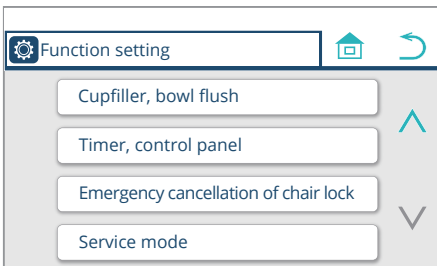

4. Press 'Bowl flush time.'  
The Bowl Flush Time setting screen appears.

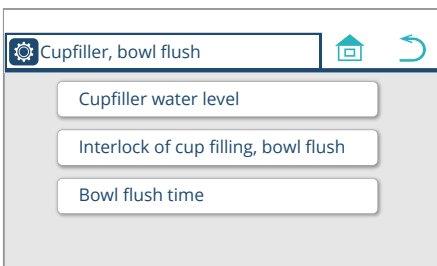

5. Press the   switches to set the time between [0] and [15] seconds.

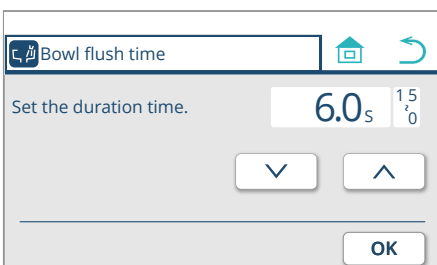

6. Press  to save the setting.  
The previous screen appears.

\* To cancel the setting, press  without pressing .

7. Press the  switch to return to the Home screen.

## 6-2-11 Setting the language

Language displayed on the touch panel can be changed.

1. Press the function switch  .  
The Function setting screen appears.

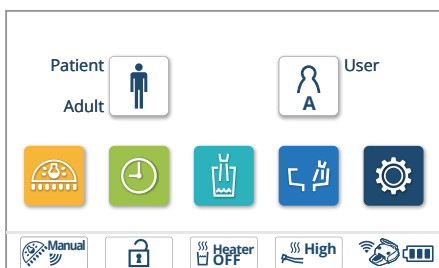

2. Press 'Language.'  
The Language setting screen appears.

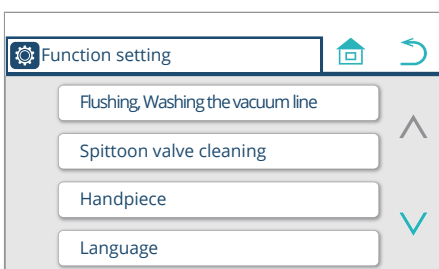

3. Press the   switches to select your language.

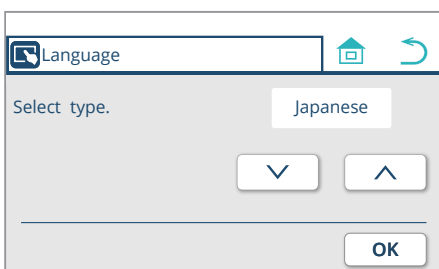

4. Press  to save the setting.  
The previous screen appears.

\* To cancel the setting, press  without pressing  .

5. Press the  switch to return to the Home screen.

## 6-2-12 Setting the timer alarm tone

Alarm tone emitted when the timer reaches zero can be set. Five tones are available and can be set to distinguish between different chairs in the same room.



1. Press the function switch .  
The Function setting screen appears.

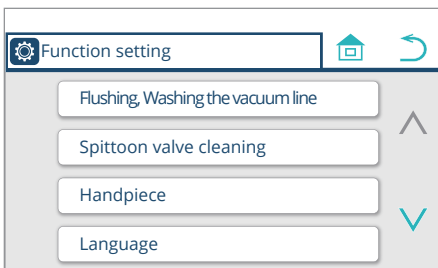

2. Press the switch.  
The second page of the Function setting screen appears.

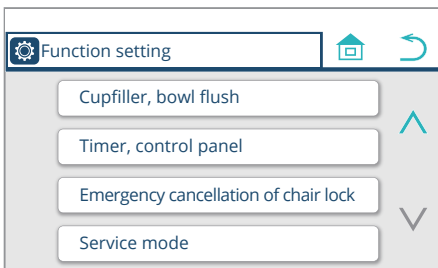

3. Press 'Timer, control panel.'

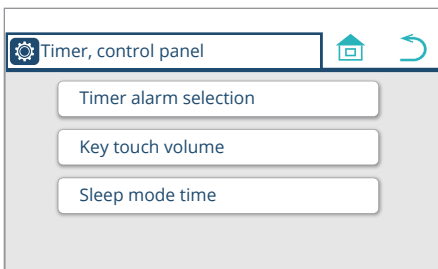

4. Press 'Timer alarm selection.'  
The Timer Alarm Selection setting screen appears.

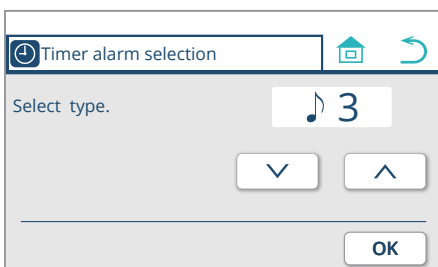

5. Press the switches to select a tone from five types ('1' to '5').

6. Press to save the setting.  
The previous screen appears.

\* To cancel the setting, press without pressing .

7. Press the switch to return to the Home screen.

## 6-2-13 Setting the key touch volume

The tone emitted when a switch is pressed can be set.

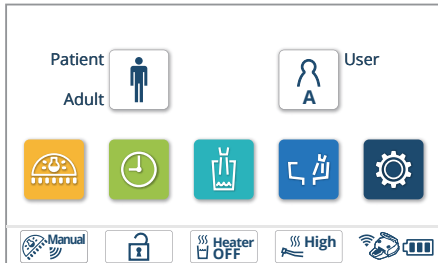

1. Press the function switch .  
The Function setting screen appears.

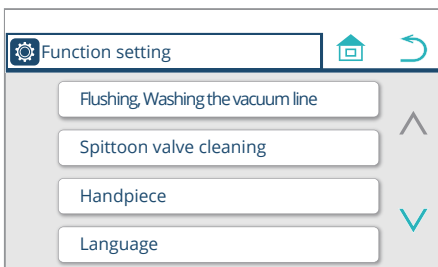

2. Press the switch.  
The second page of the Function setting screen appears.

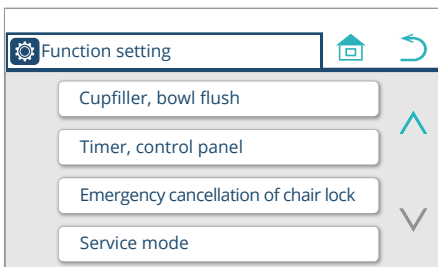

3. Press 'Timer, control panel.'

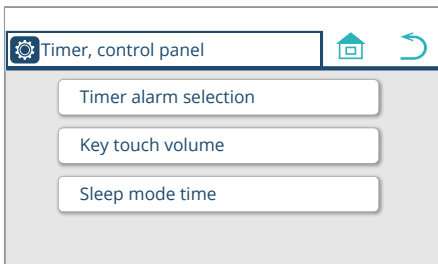

4. Press 'Key touch volume.'  
The Key touch volume setting screen appears.

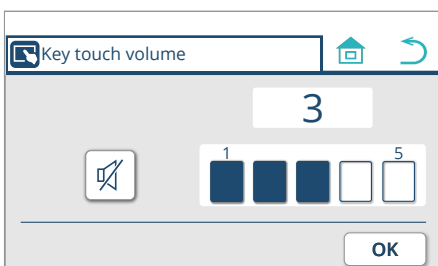

5. Press touch bar graph to set the volume in five levels ('1' to '5').

The switch makes the sound of the tone.

The switch mutes the tone.

To mute the tone, press and the display changes to .

6. Press to save the setting.  
The previous screen appears.

\* To cancel the setting, press without pressing .

7. Press the switch to return to the Home screen.



### 6-2-14 Setting the sleep mode time

When no switch on the control panel is used for a while, the touch panel screen goes dark and enters the sleep mode. The time before entering sleep mode can be adjusted.

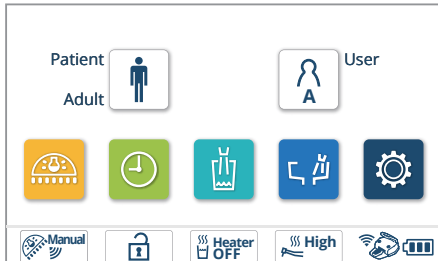

1. Press the function switch .  
The Function setting screen appears.

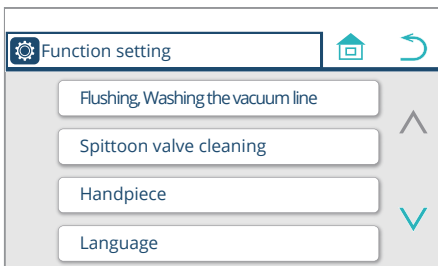

2. Press the  switch.  
The second page of the Function setting screen appears.

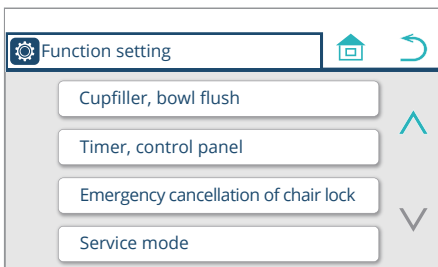

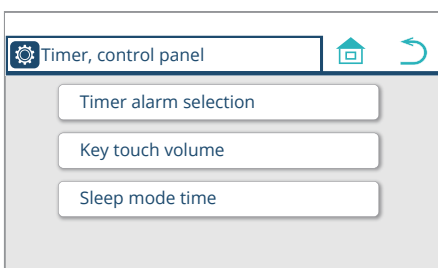

3. Press 'Timer, control panel.'

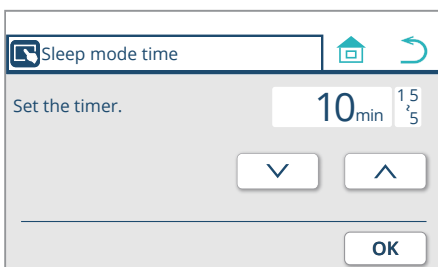

4. Press 'Sleep mode time.'  
The Sleep mode time setting screen appears.



5. Press the   switches to select one of three durations ('5 min,' '10 min,' and '15 min').

6. Press  to save the setting.  
The previous screen appears.

\* To cancel the setting, press  without pressing .

7. Press the  switch to return to the Home screen.

\* To cancel the sleep mode, touch the screen.

### 6-2-15 Setting emergency cancellation of the chair lock

The chair lock function, when activated, can be temporarily cancelled. Use this temporary cancellation only when the chair lock function must be disabled to resolve a malfunction.

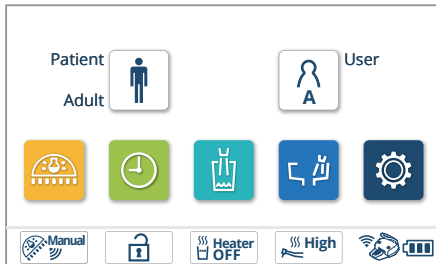

1. Press the function switch  .  
The Function setting screen appears.

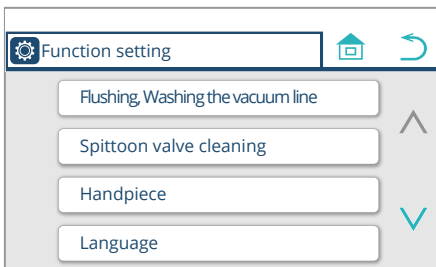

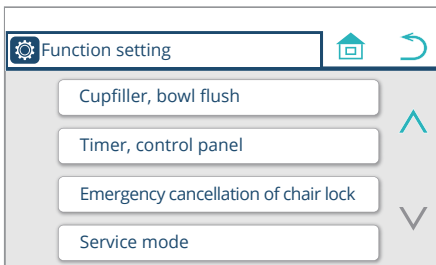

2. Press the  switch.  
The second page of the Function setting screen appears.

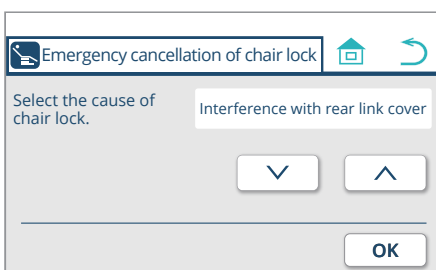

3. Press 'Emergency cancellation of chair lock.'  
The Emergency cancellation of chair lock setting screen appears.



4. Press the   switches to cancel the chair lock.  
[Reference] Chair lock function [page 104 to 106]

5. Press the  switch to save the setting.  
The previous screen appears.

\* To cancel the setting, press  without pressing  .

6. Press the  switch to return to the Home screen.

\* When the main switch is turned off, emergency cancellation of the chair lock will be disabled, and the chair lock function will be reactivated.

### 6-3 Adjusting the quantity of water/air supplied from the doctor unit

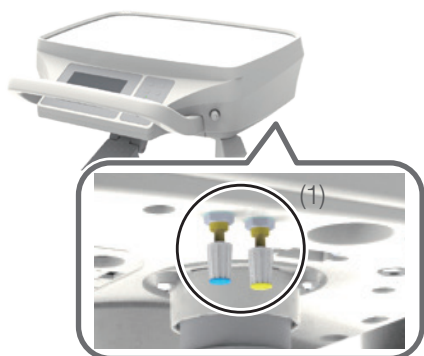

**Adjusting the quantity of water /air supplied to the syringe spray**  
The quantity of water and air supplied from the doctor unit can be adjusted with the knobs (1).

Blue cap (W side): Quantity of water supplied

Yellow cap (A side): Quantity of air supplied

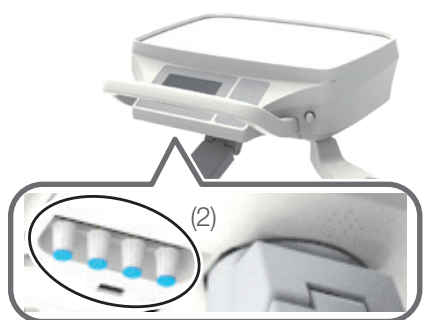

**Adjusting the quantity of water supplied to the handpiece spray**

The quantity of water supplied to the handpiece spray from the doctor unit can be adjusted with the knobs (2) (with blue caps).

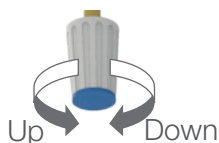

All the knobs decrease the flow rate when turned clockwise and increase it when turned counterclockwise.

Do not close the adjusting knob too tightly. It is used to increase or decrease flow rate and is not a stop valve. Note that it will idle if you close it too tightly.

Holder

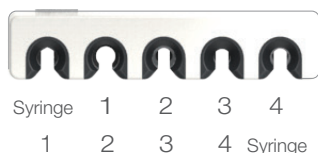

\* Correspondence between a holder and its adjusting knob (2) depends on the position of the syringe.

(See the figure on the left) Operate the system and notice the correspondence between the adjusting knob Nos. and the handpiece.

Place holder



Syringe 1 2 3 4  
1 2 3 4 Syringe

**Adjusting the quantity of water supplied to the ultrasonic scaler**

The quantity of water supplied to the ultrasonic scaler can be adjusted with the knob (3).

\* The knob (3) is only installed on systems with an ultrasonic scaler.

Fully open the adjusting knob (2) for the ultrasonic scaler when using it.

### 6-4 Adjusting the quantity of water/air supplied to the cuspidor unit

#### Maintenance panel cover

Press the maintenance panel cover (top) to open it.

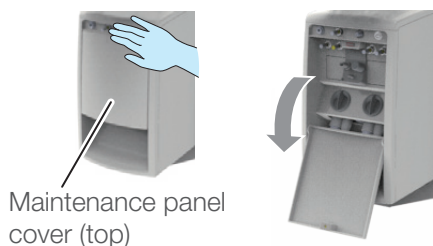

#### (1) Water supply control knob for the syringe

Adjust the quantity of water supplied to the syringe.

#### (2) Air supply control knob for the syringe

Adjust the quantity of air supplied to the syringe.

#### (3) Water supply control knob for the water service coupler

Adjust the quantity of water supplied from the water service coupler.

#### (4) Bowl flush adjusting knob

#### (5) Cupfiller adjusting knob\*

\* Knobs (5) are provided for maintenance.

They have already been adjusted to ensure the optimum water supply on installation.

The water level can be adjusted as required.

[Reference] Setting the cupfiller water level [page 178]

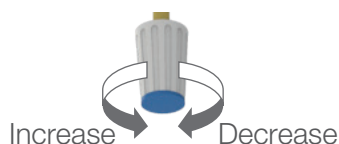

All the knobs decrease the flow rate when turned clockwise and increase it when turned counterclockwise.

Do not close the adjusting knob too tightly. It is used to increase or decrease flow rate and is not a stop valve. Note that it will idle if you close it too tightly.

### 7-1 Exterior

#### 7-1-1 Cleaning and disinfecting the surfaces

To clean and disinfect the exterior of the product (except the touch panel), wipe the surface with a soft cloth or paper towel moistened with FD366 manufactured by Dürr, and then wipe it with a dry cloth.

If the exterior is excessively dirty, moisten a soft cloth with water containing approx. 10% of neutral detergent, and wipe the exterior with the cloth. Then, wipe it with a cloth moistened with water and dry it completely with a dry cloth.

#### CAUTION

To clean and disinfect the touch panel, use ethanol for disinfection. Using other disinfectant may lead to incorrect operation, resulting in injury.

Never use any of the products listed below:

Volatile chemicals such as paint thinner, butanol, isopropyl alcohol, nail-varnish remover, gasoline, or kerosene; acid, alkaline or chlorine detergents; highly corrosive disinfectants (povidone-iodine such as Isodine, sodium hypochlorite, etc.); abrasive polishing wax or abrasive sponge

Do not use a brush or scrubber for maintenance. All of these may leave scratches and/or ingrained dirt.

If water or detergent is left on the surface, wipe it off immediately. Moisture or detergent may cause rust or failure of electrical parts.

Do not spray detergent directly onto the exterior.

Clean the surface with a soft cloth or paper towel moistened with detergent, and wipe it dry with a cloth.

If liquid enters the product, it may cause a malfunction or failure.

Confirm that the detergent has completely dried off before activating the product.

### 7-2 Chair

#### 7-2-1 Leather part

Wipe the surface with a soft cloth or paper towel moistened with FD360 manufactured by Dürr, and then wipe it with a dry cloth.

If it is excessively dirty, moisten a soft cloth with water containing approx. 10% neutral detergent, and wipe it with the cloth. Then, wipe it with a cloth moistened with water and then dry it completely with a dry cloth.

[Reference] Precautions for use of synthetic leather [Page 39]



Do not use organic solvents, detergents containing abrasives, or bleach to clean the leather part. All of these may deteriorate the surface and change texture or gloss.

Do not spray detergent directly onto the leather part or exterior. Clean the surface with a soft cloth or paper towel moistened with detergent, and wipe it with a dry cloth. The liquid may enter the product through gaps and cause a malfunction or failure.

Confirm that the detergent has completely dried off before activating the product.

## 7 Maintenance and Cleaning

### 7-3 Doctor unit

#### 7-3-1 Touch panel

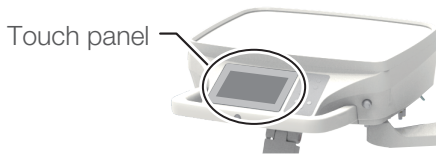

Turn off the main switch to prevent accidental depression of a switch during cleaning or disinfection.

When cleaning or disinfection while powering on the main switch, lock the touch panel of the doctor unit.

(Example) Cleaning the surface of the touch panel during the procedure.

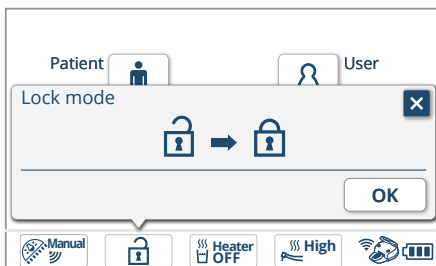

1. Open the [Lock mode] screen, and press **OK**.

The touch panel is locked.

While it is locked, a sub-window indicating the locked state is displayed on the touch panel.

2. Wipe the touch panel with a soft cloth moistened with detergent.

3. Press and hold the membrane chair/headrest switch  for one second or more.

This will unlock the touch panel operation.

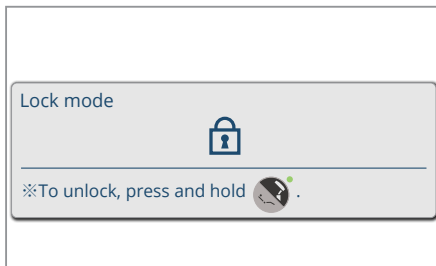

Do not spray detergent directly onto the exterior.  
Clean the surface with a soft cloth or paper towel moistened with detergent, and wipe it with a dry cloth.  
If liquid enters the product, it may cause a malfunction or failure.

### CAUTION

Be certain to wipe off all water and detergent. Otherwise, it may cause operational failure, malfunction, resulting in injury.

#### 7-3-2 Silicone mat



Autoclave them at a temperature of 134°C for 3 minutes. Or, wipe off the surface with soft cloth moistened with disinfectant FD366 manufactured by Dürr.

Before sterilization, remove dirt on the surface and wash them under running water.

Be sure to put them in a sterilization bag during the autoclave process.

Do not perform dry processing.

Repeating autoclave sterilization may cause degradation or discoloration, but doesn't affect the product functions.

If chemical solutions are spilled on the equipment, immediately wipe them off. Otherwise, discoloration may occur.

## 7 Maintenance and Cleaning

### 7-3-3 Handle cover

Holder type



Handle cover

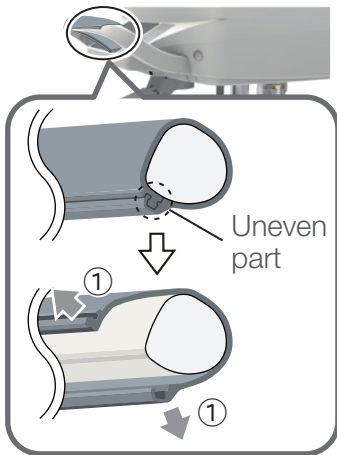

Handle cover is detachable for cleaning.

Wipe it well with a soft cloth moistened with FD366 manufactured by Dürr.

Handle cover can be autoclaved at a temperature of 134°C for 3 minutes.

Before sterilization, remove dirt on the surface and wash it under running water.

Be sure to put it in a sterilization bag during the sterilization process.

Do not perform dry processing exceeding the sterilization temperature.

[Method to detach] Holder type

① Firstly, remove the uneven part at the edge of handle cover.

② Remove the handle cover.

\* Be sure to remove it by hands.

[Method to reattach]

Reattach it in the reverse order of detaching procedures.

\* Align the uneven part of the handle cover and then reattach it.

Repeating autoclave sterilization may cause degradation or discoloration, but doesn't affect the product functions.

Do not perform dry processing exceeding the sterilization temperature.

Otherwise, deformation or discoloration may occur.

If chemical solutions are spilled on the equipment, immediately wipe them off. Otherwise, discoloration may occur.



## 7 Maintenance and Cleaning

### 7-3-4 Waste container holder

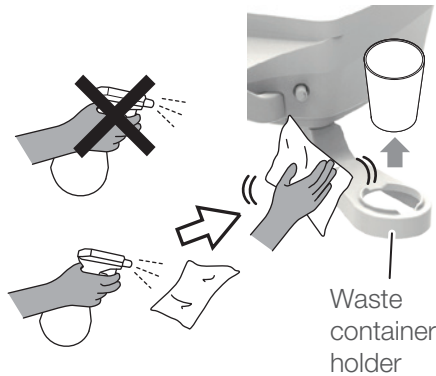

When the waste container becomes full, replace a paper cup for the waste container holder.

If the holder becomes dirty, wipe it well with a soft cloth moistened with FD366 manufactured by Dürr.

### 7-3-5 Instrument holder

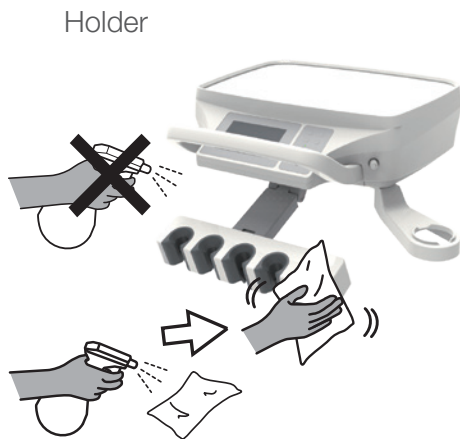

Wipe the surface with a soft cloth or paper towel moistened with FD366 manufactured by Dürr, and then wipe it with a dry cloth.

If the exterior is excessively dirty, moisten a soft cloth with water containing approx. 10% neutral detergent, and wipe the exterior with the cloth. Then, wipe it with a cloth moistened with water and then dry it completely with a dry cloth.



Never use any of the products listed below:

Volatile chemicals such as paint thinners, butanol, isopropyl alcohol, nail-varnish remover, gasoline, or kerosene; acid, alkaline, or chlorine detergents; highly-corrosive disinfectants (povidone-iodine such as Isodine, sodium hypochlorite, etc.); abrasive polishing wax, or abrasive sponge

Do not use a brush or scrubber during maintenance. All of these may leave scratches and/or ingrained dirt.

If water or detergent is left on the surface, wipe it off immediately. Moisture or detergent may cause rust or failure of electrical parts.

Do not spray detergent directly onto the leather part or exterior. Clean the surface with a soft cloth or paper towel moistened with detergent, and wipe it with a dry cloth.

If liquid may enter the product through gaps and cause a malfunction or failure.

Confirm that the detergent has completely evaporated before activating the product.

## 7 Maintenance and Cleaning

### Holder sleeve

The holder sleeves of the instrument holder are detachable for cleaning.

Wipe it well with a soft cloth moistened with FD366 manufactured by Dürr.

Sleeve No. A1 to A3 can be autoclaved at a temperature of 134°C for 3 minutes.

Sleeve No.1 to 4 cannot be autoclaved.

Before sterilization, remove dirt on the surface and wash it under running water.

Be sure to put it in a sterilization bag during the sterilization process. Do not perform dry processing exceeding the sterilization temperature.

Regarding the sleeve No. of each handpiece / syringe, refer to the table on the next page.

#### [Method to detach/reattach it]

1. Pull the lever at the lower section of the holder sleeve toward you (1).
2. While pulling the lever, push the holder sleeve upward to remove it (2).
3. To reattach it, insert it from upper side until it 'clicks' in (3).

Each holder sleeve has its No. on the bottom, and a sticker showing the same No. is attached to the instrument holder. Make sure you attach the holder sleeve to the holder with the same No.

Make sure you attach the holder sleeves to the holders with the corresponding Nos. (to the original positions) until they 'click' in. A mismatched combination will stop the product from functioning correctly.

Do not autoclave the sleeve No. 1 to 4. Autoclave sterilization may deform or degrade them.

Sleeve No. A1 to A3 can be autoclaved at a temperature of 134°C for 3 minutes.

Repeating autoclave sterilization may cause degradation or discoloration, but doesn't affect the product functions.

Do not perform dry processing exceeding the sterilization temperature.

Otherwise, deformation or discoloration may occur.

If chemical solutions are spilled on the equipment, immediately wipe them off. Otherwise, discoloration may occur.

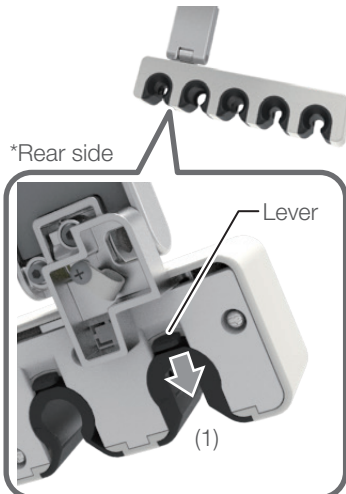

Instrument holder

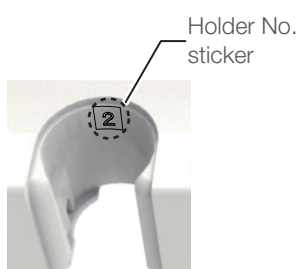
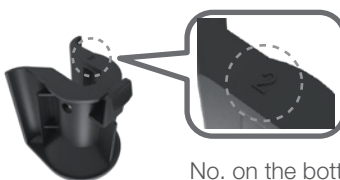
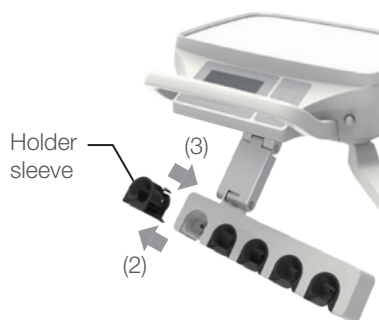

## 7 Maintenance and Cleaning

### Non-sterile type

Sleeve No.	Applicable handpiece/syringe	
1	Syringe	BT14 LUZZANI 3WAY (MINI LIGHT) LUZZANI 6WAY (MINI LIGHT)
2	Syringe  Air turbine Ultrasonic scaler Air motor	77-type 3WAY LUZZANI 3WAY (MINI MATE)  Air turbine NSK VARIOS VS170 SCALER BIEN AIR Aquilon 830 UNIFIX with LIGHT PM1132 NSK EX-203 NSK EX-6
3	Micromotor   Ultrasonic scaler  Curing light	NSK NBX NSK NLX plus NSK NLX nano BIEN AIR MX2 (DMX3) BIEN AIR MCX SATELEC Xinetic SATELEC SP4055 NEWTRON EMS NO PAIN SATELEC MINI LED STD OEM
4	Syringe Ultrasonic scaler	DCI NSK VARIOS VS170 LUX SCALER DENTSPLY CAVITRON SCALER (TYPE G139) SATELEC SP4055 NEWTRON SLIM

### Sterilizable type

Sleeve No.	Applicable handpiece/syringe	
A1	Syringe Air turbine	77-type 3WAY Air turbine
A2	Syringe  Micromotor   Ultrasonic scaler  Curing light	BT14 LUZZANI 3WAY (MINI LIGHT) LUZZANI 6WAY (MINI LIGHT) BIEN AIR MCX BIEN AIR MX2 (DMX3) NSK NBX NSK NLX plus NSK NLX nano NSK VARIOS VS170 SCALER SATELEC Xinetic SATELEC SP4055 NEWTRON EMS NO PAIN SATELEC MINI LED STD OEM
A3	Syringe  Ultrasonic scaler	DCI LUZZANI 3WAY (MINI MATE) NSK VARIOS VS170 LUX SCALER DENTSPLY CAVITRON SCALER (TYPE G139) SATELEC SP4055 NEWTRON SLIM

## 7 Maintenance and Cleaning

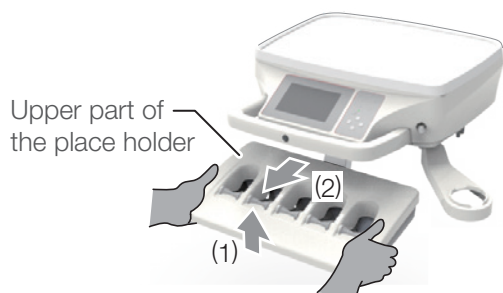

### Place holder

Upper part of the place holder is detachable for cleaning.

#### [Method to detach/reattach it]

1. Hold the upper part of the place holder with both hands and pull it upward slightly. (1)
2. Pull it toward you and remove it. (2)
3. To reattach it, insert it to the original position from the upper side. (3)

### 7-3-6 Cleaning of 77-type 3WAY syringe

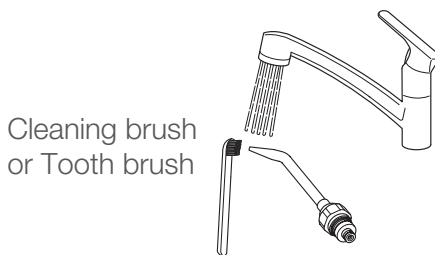
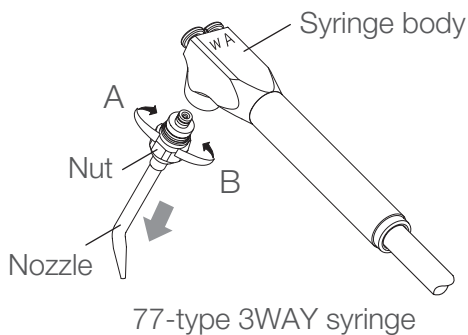

Cleaning 77-type 3WAY syringe Nozzle

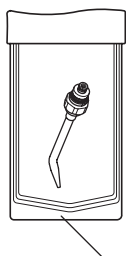

#### Disassembly

Remove the nozzle from syringe by turning it in direction A.

#### Cleaning by hand

1. Wipe off the surface contamination by a cloth while rinsing the surface by running clean warm water at  $40\pm 5$  °C. Scrub the tip and joint part of nozzle by a cleaning brush or by a tooth brush with running clean warm water at  $40\pm 5$  °C.
2. Check whether contamination is removed or not after cleaning. Continue the cleaning if contamination is remained.
3. Immersed with an alkaline disinfection or detergent for 5 minutes. (We recommend to use ID212 made by Dürr)
4. Rinse thoroughly by distilled water at ordinary temperature or by clean water for more than 1 minute.  
After sterilizing the handpiece, keep it in the sterilization pouch and store in a dark and cool place.



### CAUTION

Cleaning must be done every after use to patients.

Cleaning must be done within 1 hour after use.

Replace with a new syringe nozzle if contamination and solid material attached to syringe nozzle can not be removed.

#### Sterilization

Sterilization must be done every after use to patients.

The nozzle can be sterilized with autoclave. Sterilization with autoclave is permitted up to 250 times.

1. Insert the handpiece in a sterilization pouch and seal it.

2. Autoclave for 3 min. at  $134^{\circ}\text{C}$  and dry for 15 min.

Apply Vaseline thinly and evenly to the two O-rings after sterilization.

Tighten the nut firmly in direction B to undo the nozzle.

#### Storage:

After sterilizing the pouch and store in a dark and cool place.

Recommended cleaner : Orotol Plus made by Dürr.



### CAUTION

Sterilization must be done every after use to patients.

Sterilization by class B cycles.

Sterilization temperature is  $135^{\circ}\text{C}$  or less.

Dry naturally if the temperature for drying process is to exceed  $135^{\circ}\text{C}$ .

If damage occurs to the sterilization pouch, discard and sterilize again using a new pouch.

Before use, make sure that the nut is firmly tightened.

### 7-3-7 Handpiece hose

When the handpiece becomes dirty, wipe it well with a soft cloth moistened with FD366 manufactured by Dürr.

Do not spray detergent directly onto the exterior. Clean the surface with a soft cloth or paper towel moistened with detergent, and wipe it with a dry cloth. If liquid enters the product, it may cause a malfunction or failure. Confirm that the detergent has completely evaporated before activating the product.

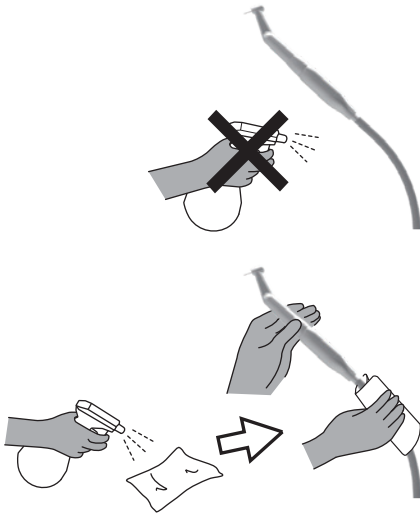

### 7-3-8 Oil mist separator

This unit collects oil from the exhaust air from the handpiece.

When oil reaches to the line on the oil reservoir (1), make sure you discard the oil.

Turn the oil reservoir counterclockwise to remove.

If the hygroscopic sponge (2) (consumable) is excessively dirty or has excessive oil on it, replace it.

Contact your local authorized Belmont dealer for a replacement for the hygroscopic sponge. (Replacement will be charged for.)

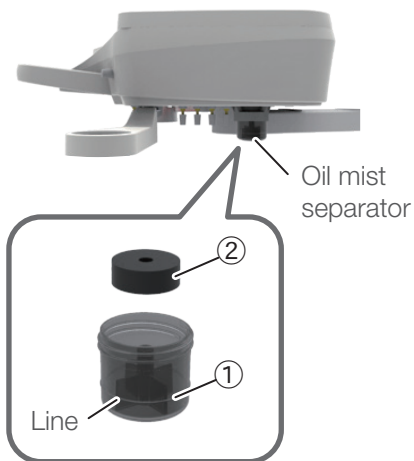

## 7-4 Cuspidor unit

### 7-4-1 Assistant holder

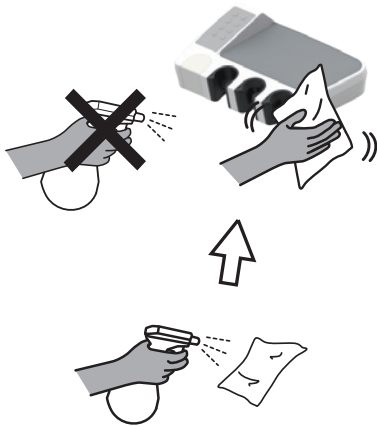

Wipe the surface with a soft cloth or paper towel moistened with FD366 manufactured by Dürr, and then wipe it with a dry cloth.

If the exterior is excessively dirty, moisten a soft cloth with water containing approx. 10% neutral detergent, and wipe the exterior with the cloth. Then, wipe it with a cloth moistened with water and then dry it completely with a dry cloth.

Never use any of the products listed below:

Volatile chemicals such as paint thinners, butanol, isopropyl alcohol, nail-varnish remover, gasoline, or kerosene; acid, alkaline, or chlorine detergents; highly-corrosive disinfectants (povidone-iodine such as Isodine, sodium hypochlorite, etc.); abrasive polishing wax or abrasive sponge.

Do not use a brush or scrubber during maintenance. All of these may leave scratches and/or ingrained dirt.

If water or detergent is left on the surface, immediately wipe it off. Any remaining moisture or detergent may cause rust or failure of electric parts.

Do not spray detergent directly onto the exterior.

Clean the surface with a soft cloth or paper towel moistened with detergent, and wipe it with a dry cloth.

If liquid enters the product, it may cause a malfunction or failure. Confirm that the detergent has completely evaporated before activating the product.

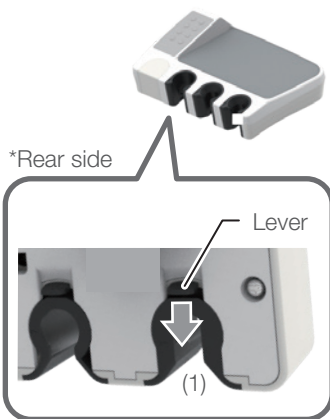

Assistant holder

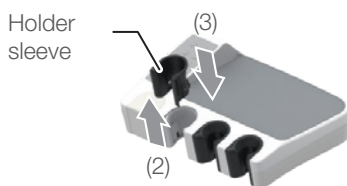

### Holder sleeve

The holder sleeves of the instrument holder are detachable for cleaning.

Wipe it well with a soft cloth moistened with FD366 manufactured by Dürr.

Sleeve No. A1 to A4 can be autoclaved at a temperature of 134°C for 3 minutes.

Sleeve No.1 to 6 cannot be autoclaved.

Before sterilization, remove dirt on the surface and wash it under running water.

Be sure to put it in a sterilization bag during the sterilization process. Do not perform dry processing exceeding the sterilization temperature.

Regarding the sleeve No. of each handpiece / syringe, refer to the table on the next page.

#### [Method to detach/reattach it]

1. Pull the lever at the lower section of the holder sleeve toward you (1).
2. While pulling the lever, push the holder sleeve upward to remove it (2).
3. To reattach it, insert it from upper side until it 'clicks' in (3).

## 7 Maintenance and Cleaning

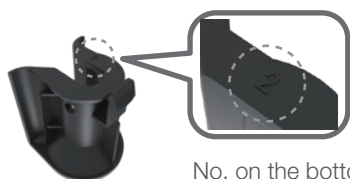

No. on the bottom of the holder sleeve

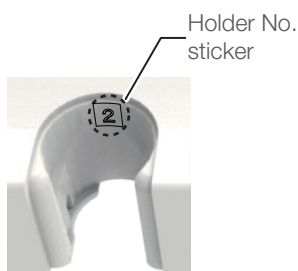

Holder No. sticker

Each holder sleeve has its No. on the bottom, and a sticker showing the same No. is attached to the assistant holder. Make sure you attach the holder sleeve to the holder with the same No.

Make sure you attach the holder sleeves to the holders with the corresponding Nos. (to the original positions) until they 'click' in. A mismatched combination will stop the product from functioning correctly.

Do not autoclave the sleeve No. 1 to 6. Autoclave sterilization may deform or discolor them.

Sleeve No. A1 to A4 can be autoclaved at a temperature of 134°C for 3 minutes.

Repeating autoclave sterilization may cause degradation or discoloration, but doesn't affect the product functions.

Do not perform dry processing exceeding the sterilization temperature. Otherwise, deformation or discoloration may occur.

If chemical solutions are spilled on the equipment, immediately wipe them off. Otherwise, discoloration may occur.

### Non-sterile type

Sleeve No.	Applicable handpiece/syringe	
1	Syringe	BT14 LUZZANI 3WAY (MINI LIGHT) LUZZANI 6WAY (MINI LIGHT)
2	Syringe	77-type 3WAY LUZZANI 3WAY (MINI MATE)
3	Curing light	SATELEC MINI LED STD OEM
4	Syringe Saliva ejector handpiece	DCI DURR
5	Vacuum handpiece	VH-18 DURR
6	Saliva ejector handpiece	BT06

### Sterilizable type

Sleeve No.	Applicable handpiece/syringe	
A1	Syringe	77-type 3WAY
A2	Syringe Curing light	BT14 LUZZANI 3WAY (MINI LIGHT) LUZZANI 6WAY (MINI LIGHT) SATELEC MINI LED STD OEM
A3	Syringe Saliva ejector handpiece	DCI LUZZANI 3WAY (MINI MATE) DURR
A4	Vacuum handpiece	VH-18 DURR



### 7-4-2 Assistant hose clamp

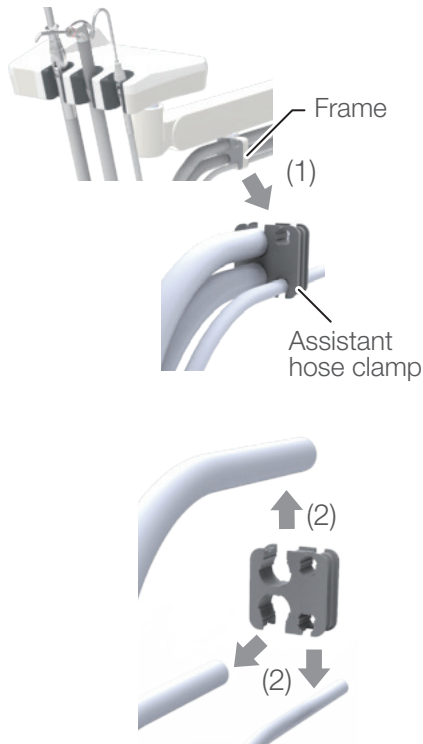

Assistant hose clamp of the assistant unit is detachable from the frame, which is suitable for cleaning. When it becomes dirty, wipe it well with a soft cloth moistened with FD366 manufactured by Dürr.

[Method to detach]

- (1) Remove the assistant hose clamp from the frame.
  - \* Be sure to remove it by hands.
- (2) Remove the hose from the assistant hose clamp.

[Method to reattach]

Reattach it in the reverse order of detaching procedures.

Do not autoclave them.  
Autoclave sterilization may deform or discolor them.

### 7-4-3 Assistant silicone mat

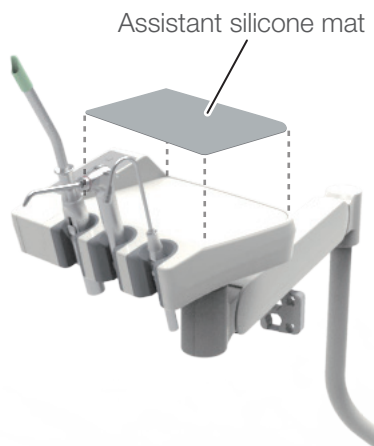

Autoclave them at a temperature of 134°C for 3 minutes. Or, wipe off the surface with soft cloth moistened with disinfectant FD366 manufactured by Dürr.

Before sterilization, remove dirt on the surface and wash them under running water.

Be sure to put them in a sterilization bag during the autoclave process.

Do not perform dry processing.

Repeating autoclave sterilization may cause degradation or discoloration, but doesn't affect the product functions.

If chemical solutions are spilled on the equipment, immediately wipe them off. Otherwise, discoloration may occur.

## 7-4-4 Washing and sterilizing the vacuum handpiece and saliva ejector handpiece

Wash and sterilize the handpieces between patients. To properly sterilize the vacuum and saliva ejector handpieces, it is necessary to wash them to remove dirt and immerse them in detergent. Then, rinse them to remove any remaining detergent. Follow the procedure below to wash and sterilize the handpieces.

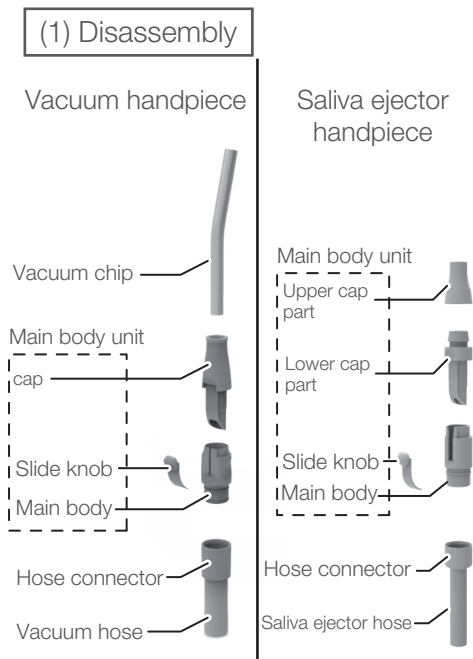

### (1) Disassembly

To prepare for washing, disassemble the handpieces as shown in the figure.

Hold the hose connector, and pull the vacuum hose and saliva ejector hose to detach them from the main body.

### (2) Washing the surface

Rinse the surface with clean water (tap water) warmed to a temperature of  $40 \pm 5^\circ\text{C}$ , and rub it with a cloth to remove dirt. When all dirt is removed, wipe it dry.

### (3) Washing the interior and sliding groove

Rinse the interior and sliding groove of the main body with clean water (tap water) warmed to a temperature of  $40 \pm 5^\circ\text{C}$ , and scrub them with a scrubbing brush or toothbrush. When all dirt is removed, wipe them dry.

### (4) Washing parts inaccessible with a brush

If some parts are inaccessible with a brush, rub them with a cloth. Rinse them well with clean water (tap water) warmed to a temperature of  $40 \pm 5^\circ\text{C}$  (for at least 1 minute).

Immerse the parts in ID212 manufactured by Dürr or alkaline cleaner for 5 minutes. Then, rinse them well with clean water (tap water) warmed to a temperature of  $40 \pm 5^\circ\text{C}$  (for at least 1 minute). Inspect the parts for any visible dirt. If any visible dirt remains, repeat the above washing process.

### (2) Washing the surface



### (3) Washing the interior and sliding part

Scrubbing brush or toothbrush

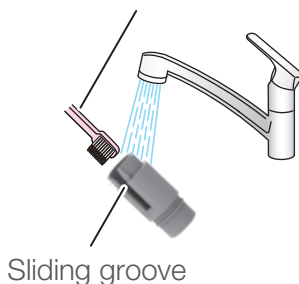

### (4) Washing parts inaccessible with a brush

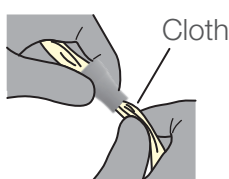

Wash them immediately after use.

If the parts are in the condition described below after washing, do not autoclave them. Replace them.

A hole/holes are clogged, and dirt cannot be removed.

Dirt on some parts or solid dirt cannot be removed.

## 7 Maintenance and Cleaning

Caution when assembling vacuum handpiece before sterilization  
VH-18

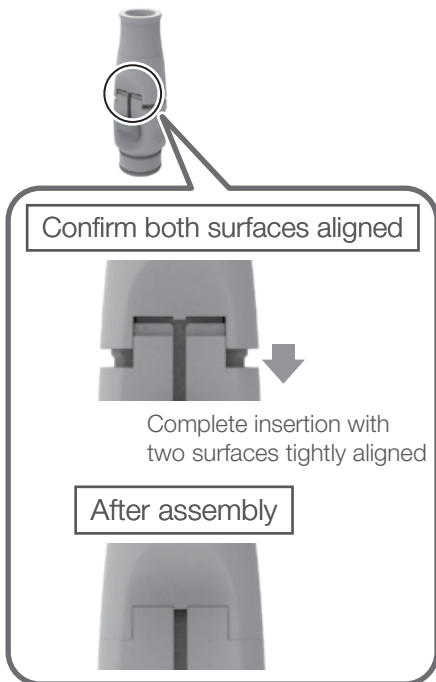
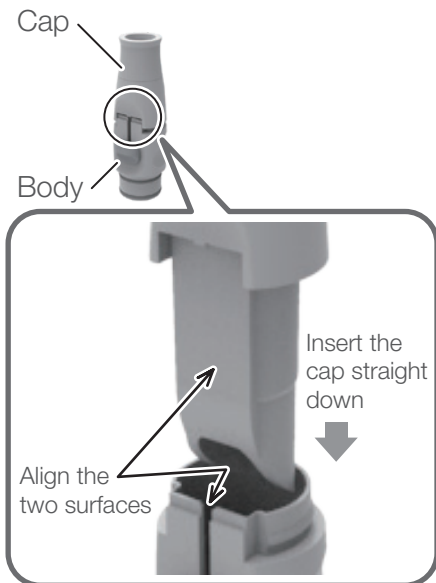

Vacuum handpiece



Saliva ejector handpiece



Sterilization bag

### (5) Sterilization

The vacuum handpiece and saliva ejector handpiece are autoclavable. Reassemble the main body unit, and autoclave the vacuum and saliva ejector handpieces.

When assembling the vacuum handpiece, align the two surfaces; a flat surface of the cap and the surface of the sliding groove of the body. Then, slide the cap into the body straight.  
\* Do not insert it twisted.

1. Put the handpiece in a sterilization bag, and seal the opening.
2. Autoclave sterilization

Sterilization temperature and sterilization time for each vacuum handpiece are as follows.

DURR : 134°C for 5 minutes.

VH-18 / BT06 : 134°C for 3 minutes.

If the temperature is to exceed 135°C during the drying process, do not perform the drying process and dry naturally.  
The handpieces can be autoclaved up to 250 times.

Storage method: After sterilization, store the handpiece in the sterilization bag in a dark, cool place.

## 7 Maintenance and Cleaning

Vacuum handpiece

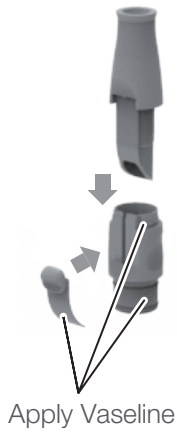

Saliva ejector handpiece

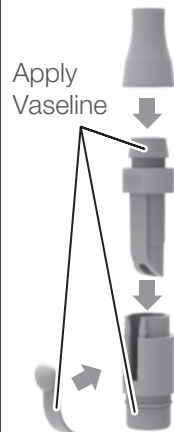

After autoclave sterilization, disassemble the handpieces, apply Vaseline, and reassembly before use.

If the handpieces are used without Vaseline, a packing may be damaged, resulting in leakages.

Vacuum handpiece

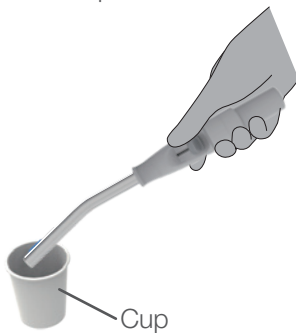

Saliva ejector handpiece



### Vacuum handpiece / Saliva ejector handpiece

Suction a cup of water (approx. 100 ml) or more into the vacuum and saliva ejector handpieces after use by a patient. This is to clean and dilute the medicine used and to prevent the handpieces deteriorating.

Some medicines used for the procedure may cause deterioration of the handpiece. It may dissolve, deform, or damage part of the handpiece, possibly resulting in leaks from the handpiece or suction failure. This will ultimately makes the handpiece unusable. Please wash them properly to ensure long-term use.

### Vacuum hose / Saliva ejector hose

The vacuum hose and saliva evacuation hose can be removed by holding the joint and pulling the hose.

The exterior of the hose can be washed under tap water.

\* For washing the hose interior (of the vacuum and saliva ejector lines), refer to [Page 205].

To reattach the hose, insert the joint into the receptacle.

Always turn off the main switch before pulling the hose off to wash it.

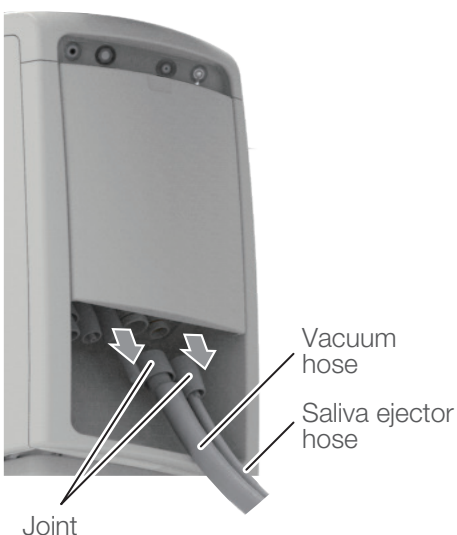

### 7-4-5 Vacuum line / Saliva ejector line



Handpieces for vacuum and saliva ejector suction the secretions, saliva, or blood that contains bacteria. Therefore, always wash and sterilize them using Orotol plus® manufactured by Dürr after the procedure.

Do not use any detergent except our designated one. Otherwise, strong acidic detergents or alkaline drain preparations may cause clog, damage, or metal corrosion.

### 7-4-6 Cleaning of 77-type 3WAY syringe

[Reference] Cleaning of 77-type 3WAY syringe [page 197]

### 7-4-7 Sensor window for cupfiller

Wipe the surface with a soft cloth or paper towel moistened with FD366 manufactured by Dürr, and then wipe it with a dry cloth.



If the exterior is excessively dirty, moisten a soft cloth with water containing approx. 10% neutral detergent, and wipe the exterior with the cloth. Then, wipe it with a cloth moistened with water and then dry it completely with a dry cloth.

## 7-4-8 Cuspidor bowl

### Cuspidor bowl / Cupfiller unit

Use MD550 manufactured by Durr as detergent for cuspidor bowl.

#### (1) Cuspidor bowl

The cuspidor bowl is detachable and can be washed under tap water. Lift it in the direction shown with the arrow to detach it.

After reattaching it, check that it is securely mounted before use.

### CAUTION

Put on the cleaning gloves when detaching cuspidor bowl.

Cuspidor bowl is made of ceramic that might cause injury when broken.

Always turn off the main switch before detaching the cuspidor bowl.

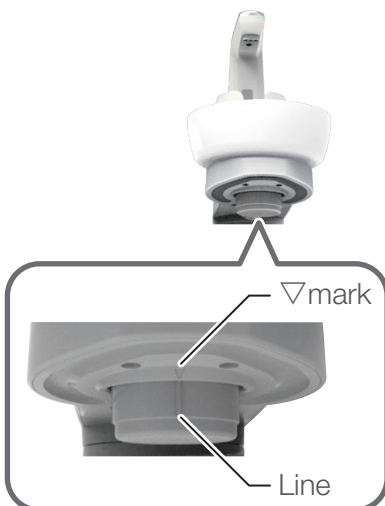
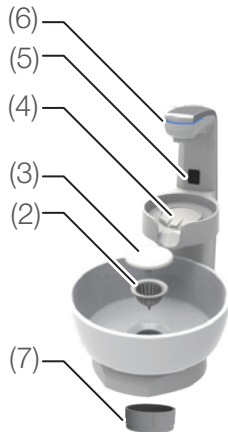

#### (2) Strainer (3) Drain outlet cover

Since the strainer easily gets clogged, detach the (3) drain outlet cover and clean the filter after consulting hours every day.

#### (4) Cupfiller base (5) Sensor window for cupfiller

Before cleaning, turn off the main switch, or switch the mode to the sensor disabled mode. [Page 136]

#### (6) LED indicator

Wipe the LED indicator with a soft cloth moistened with FD366 manufactured by Dürr to remove dirt and water droplets.

#### (7) Lower section of the drain trap

If the drain trap has not been completely drained, dirt may accumulate on the inside wall. Turn the cuspidor bowl by 90 degrees as shown in the figure, turn the (7) lower section of the drain trap counterclockwise to detach, and clean it. When detaching the (7) lower section of the drain trap, dirty water may overflow from the inside. Always detach the (2) strainer and (3) drain outlet cover, and flush out the cuspidor bowl with a cup of water before detaching the (7) lower section of the drain trap. (This reduces the quantity of dirty water in the drain trap.)

To reattach it, rotate the lower section of the drain trap clockwise until the vertical line meets the triangle mark.

When the lower section of the drain trap is detached, do not flush water in the cuspidor bowl.

To avoid the odor from the drain, flush the cuspidor bowl after cleaning.

## 7 Maintenance and Cleaning

Do not use sandpaper, wire wool, abrasive sponge, or abrasive cleaner.

Do not use any detergent except our designated one. Otherwise, strong acidic detergents or alkaline drain preparations may cause clog, damage, or metal corrosion.

Do not allow any metal object to come into contact with the cuspidor bowl when detaching or reattaching it since contact may leave a metal mark. If the metal object marks the bowl, use a metal mark removing agent (commercially available).

\* A metal mark is a black or silver line caused by strong contact and friction between the ceramic surface and the metal object.

Before detaching or reattaching the cuspidor bowl, always turn off the main switch. When cleaning the cupfiller base, turn off the main switch, or switch the mode to the sensor disabled mode.

When detaching or reattaching the bowl, the cupfiller sensor may detect your hand or other object, causing water for flushing the bowl or cupfiller base to splash around, which can cause metal parts to rust.

The cuspidor bowl is made of ceramic. It may break if it receives a hard knock. Do not wash it with boiling water, as this may break it.

Since the cuspidor bowl can be easily detached or reattached, do not apply excessive force except when washing. (Do not knock it, hit it, or drop it.)

Do not pour water over the cupfiller base when cleaning it. It is not waterproof, and excessive water may cause it to malfunction. For cleaning the cupfiller base, refer to the [page 206].

Do not let water flow onto the cupfiller base. The drainage function of the cupfiller base is designed to drain away any overflow water when filling a cup.

# 7 Maintenance and Cleaning

## 7-4-9 Solid collector

After consulting hours, remove the filter from the solid collector in the cuspidor unit, and wash it.

Accumulated debris may degrade the suction force of the vacuum handpiece or saliva ejector handpiece.

[Method to detach/reattach the filter]

1. Press the maintenance panel cover (top) of the cuspidor unit to open it.

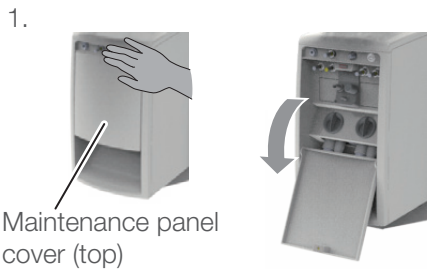

2. Pull off the solid collector.



3. Detach the solid collector cap from the filter.

Pull the filter to detach the solid collector cap as shown in the figure on the left.

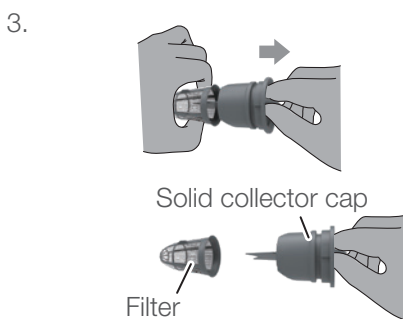

4. Wash the solid collector cap and the filter under running water.

5. Align the claw on the solid collector cap with the groove on the filter to attach them.



6. Attach the solid collector in its original position with the cap aligned as shown in the left figure.

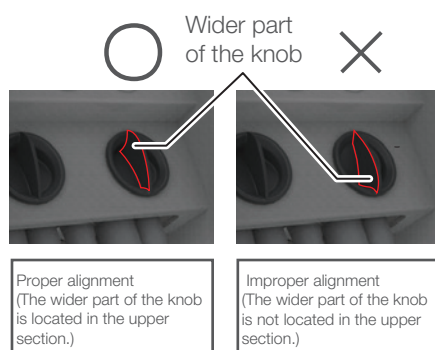

Press the solid collector into the end of the receptacle with the proper alignment. If it is improperly mounted, the vacuum handpiece and saliva ejector handpiece may not function properly.



## 7 Maintenance and Cleaning

### 7-4-10 Spittoon valve

Clean the Spittoon valve twice in a day at the end of morning treatment and evening treatment. (At the end of evening treatment if cleaning once in a day.)

1. Press the function switch  .  
The Function setting screen appears.

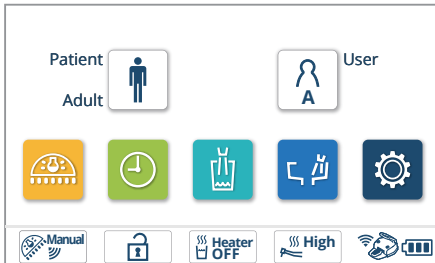

2. Press 'Spittoon valve cleaning'.  
Spittoon valve cleaning screen appears.

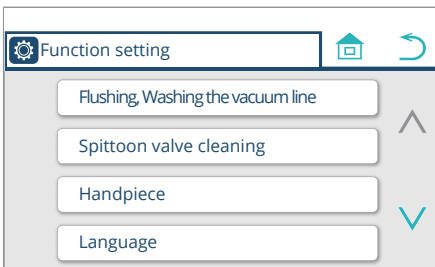

3. Add 1 liter of diluted solution of "Orotol plus" into the cuspidor bowl, then press  .

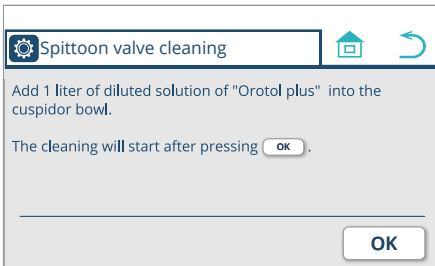

4. Spittoon valve cleaning starts  
'Spittoon valve in cleaning' message appears on the screen.

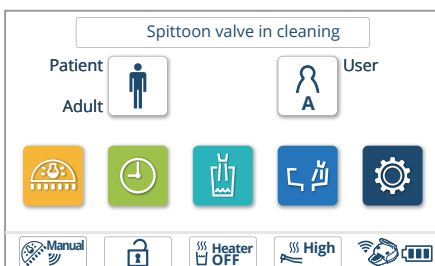

5. Spittoon valve cleaning finishes  
'Spittoon valve in cleaning' message disappears from the screen.

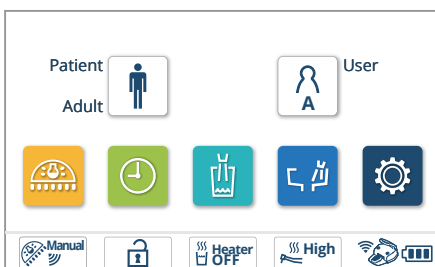

## 7 Maintenance and Cleaning

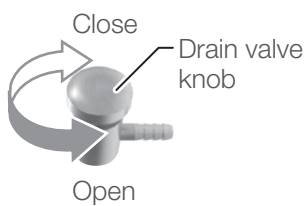
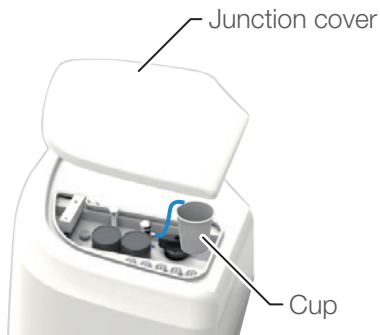

### 7-4-11 Air filter

Empty any water that has collected in the air filter at least once a week.

1. Open the Junction cover.
2. Prepare a cup to put the water in.
3. Turn the drain valve knob counterclockwise, and discharge the water into the cup.
4. When no more water comes out, turn the drain valve knob clockwise to close it.

After closing the drain valve knob, water remained in the tube may come out.

Wipe the water with cloth to prevent the water from coming out.

If any water gets into the air line, it may cause a failure of the product.

### 7-4-12 Air compressor

For maintenance of the air compressor, follow the Instructions for Use supplied with the air compressor.

### 7-4-13 Vacuum pump

For maintenance of the vacuum pump, follow the Instructions for Use supplied with the vacuum pump.

### 7-5 How to detach battery of the doctor unit

Instrument delivery: Holder/Place holder

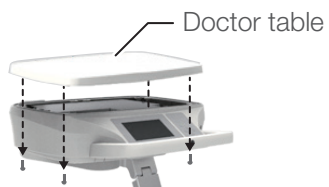

1. Remove the four screws under the doctor table and detach the doctor table.

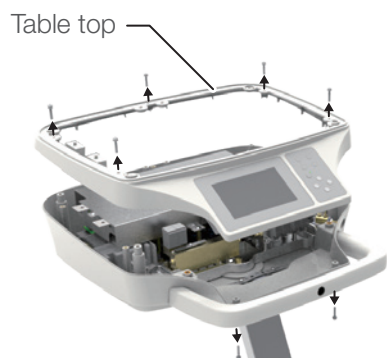

2. Remove the seven screws and detach the table top.

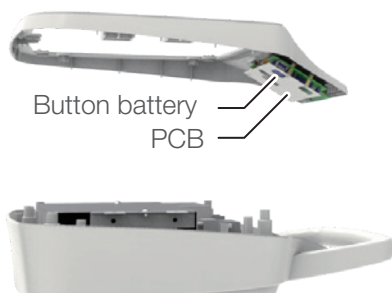

3. Detach the button battery (CR1632) on the PCB.

## 7 Maintenance and Cleaning

### 7-6 Maintenance and inspection

#### Notes on daily maintenance and inspection (by the user)

It is the responsibility of the user (medical institution) to ensure that the medical device is correctly maintained and inspected. To ensure safe use of this product, the unit must be inspected at the specified intervals as described in the table below:

No	Inspection item	Inspection interval	Inspection procedure and criteria	Outcome if inspection is not conducted	Maintenance required when the inspection criterion is not satisfied
1	Check the cancel function	Before consulting hours	When the chair is in automatic operation, it must stop when any of the operation switches shown on [Page 102] is pressed or stepped on.	The chair unexpectedly moves during procedure, resulting in an injury. The patients may be caught between the doctor unit and the chair, resulting in an accident.	If the chair does not stop, please contact your local authorized Belmont dealer.
2	Check for water, air and oil leaks	Before consulting hours	Check that no water, air or oil leaks out from the product.	The product does not function properly, preventing proper treatment or procedure.	If water, air or oil leaks out, please contact your local authorized Belmont dealer.
3	Cup-filling	Before consulting hours	Place a cup on the cupfiller base, and check that the cup is detected and correctly filled. * Use a cup with a weight of 3 grams or more.	The cup is not filled with water in some cases.	Follow the description under 'Cupfiller,' and inspect it again.[Page 136] If it cannot be solved after re-inspection, please contact your local authorized Belmont dealer.
4	Check the functioning of each handpiece	Before consulting hours	(1) Check that the turbine rotates properly and that the correct quantities of water and air are supplied. (2) Check that the micromotor rotates properly and that the correct quantity of water is supplied. (3) Check that the ultrasonic scaler vibrates properly and that the correct quantity of water is supplied. (4) Check that the correct quantities of water and air are supplied from syringe.	The patient may receive an injury to their mouth, or the handpiece may malfunction.	Adjust the quantity of water or air. [Page 187] For other failures, please refer to the Instructions for Use for the respective handpieces. If the problem still persists, please contact your local authorized Belmont dealer.
5	Check the correct burr for the turbine, air motor, and micromotor is mounted.	Before each patient	Check that the correct burr is securely mounted. Make sure you refer to the Instructions for Use for the turbine, air motor and micromotor. Check that the burr is free of any defect (damage or deformation).	The burr will not rotate freely, resulting in an accident.	If the burr is damaged, deformed or has some other defect, replace the burr by following the Instructions for Use for the turbine, air motor and micromotor.
6	Check the scaler tip	Before each patient	Check that the correct tip is securely mounted and properly used. Refer to the Instructions for Use for the scaler. Check that the tip is free from any defect (wear or deformation).	The tip will not vibrate properly, resulting in an accident.	If the tip is worn or deformed, replace it by following the Instructions for Use for the scaler. For other defects, please contact your local authorized Belmont dealer.
7	Check that the syringe nut is tight	Before each patient	Check that the nut that secures the nozzle of the Type 77 / Radis 3-way syringe is securely tightened.	The nut may come off, resulting in an accident.	Follow the Instructions for Use for the Type 77 3-way syringe to tighten the nut that secures the nozzle and confirm secure tightening.
8	Debris on the micromotor	After consulting hours	Check that no excess oil from the handpiece adheres to the motor unit.	The motor unit may not function properly, resulting in a malfunction.	Follow the Instructions for Use for the micromotor to maintain it.
9	Maintenance Vacuum handpiece / saliva ejector handpiece	After consulting hours	Wash the vacuum lines and saliva ejector lines.	Suction is defective.	Wash the vacuum lines. [Page 205]

## 7 Maintenance and Cleaning

No	Inspection item	Inspection interval	Inspection procedure and criteria	Outcome if inspection is not conducted	Maintenance required when the inspection criterion is not satisfied
10	Maintenance Cuspidor bowl	After consulting hours	Check that the cuspidor bowl does not contain any dirt (or excrescence). Check that no dirt has collected on the dirt filter.	Draining is defective.	Clean the cuspidor bowl and dirt filter. [Pages 206, 207]
11	Maintenance Solid collector	After consulting hours	Check that no dirt has collected on the solid collector.	Suction power of the vacuum handpiece or saliva ejector handpiece has decreased.	Clean the filter. [Page 208]
12	Maintenance Exterior	After consulting hours	Check that no chemical solution or dirty water adheres to or remains on the exterior of the product.	Any liquid remaining will cause discoloration or change the properties of the exterior or cause metal parts to rust.	Clean it. [Page 189]
13	Check the main switch and main water valve	After consulting hours	Check that the main switch is turned off, and the main water valve is closed .	May result in a short circuit or water leaks.	If the main switch cannot be turned off or the main water valve cannot be closed, please contact your local authorized Belmont dealer.
14	Movable parts of the product	Once a week	When operating the product, check that no movable parts emit any abnormal noise.	The product does not function properly, preventing proper treatment or procedure.	If any movable parts emit an abnormal noise, please contact your local authorized Belmont dealer.
15	Maintenance Drain valve	Once a week	Drain water from the drain valve on the air filter.	Water enters the air line, resulting in a malfunction.	Always drain the air filter. [Page 210]
16	Check water and pneumatic pressures	Once a month	Check the water and pneumatic pressures using the pressure gauge on the maintenance panel. Main water pressure : 0.1 to 0.2 MPa Main air pressure : 0.45 to 0.5 MPa	The product does not function properly, preventing proper treatment or procedure.	If the pressure is out of the range of the main water pressure/main air pressure, please contact your local authorized Belmont dealer.
17	Check the doctor unit	Once a month	The doctor table is level and stops at the specified position.	Objects fall from the doctor table, resulting in an injury or accident.	If the doctor table is not level or does not stop at the specified position, please contact your local authorized Belmont dealer.
18	Oil mist separator	Once a month	The drain oil does not reach the line on the oil mist separator.	The handpiece may not function properly due to an exhaust failure.	Empty the oil. [Page 198]



### WARNING

Always refer to this Guide and the Instructions for Use supplied with each device (such as the dental light and handpieces) before conducting daily maintenance and inspection.

If you do not conduct daily maintenance or inspection, use of the product may result in injury or damage to nearby devices.

### Notes for periodic inspection

The product contains parts that stop functioning or wear depending on the use frequency, and therefore it is important to carry out maintenance in a periodic inspection once a year (including replacement of consumables) and safety checks.

Service parts required for the periodic inspection (including consumables) are listed in the table below. However, depending on the specifications of your device, there may be alternative parts available that differ from those listed in the table below.

Maintenance and inspection can be outsourced to qualified persons such as authorized repairers of medical devices.

If you have any question about periodic inspection, contact your local authorized Belmont dealer.

### List of service parts required for the periodic inspection

Part name	Standard service life	Part name	Standard service life
Movable part	7 years	Switch	5 years
Wire for a movable part	5 years	PC board	5 years

### List of consumables required for periodic inspection

Part name
O-ring
Packing
Diaphragm



Always entrust periodic inspection to your local authorized Belmont dealer.

If you do not carry out periodic inspection, use of the product may cause injury or damage to nearby devices.

### 7-7 Detachable parts

Part name	Part name
Handpiece	Vacuum tip
Handpiece hose	Saliva ejector nozzle
Holder sleeve	Solid collector cap
Cuspidor bowl	Solid collector filter
Cover for the drain outlet of the cuspidor bowl	Water service coupler
Cuspidor bowl strainer	Air service coupler
Vacuum handpiece	Syringe nozzle
Saliva ejector handpiece	Syringe body
Oil mist separator	Syringe hose

### 7-8 Storage method

If the product is not used for an extended period of time after consulting hours or during holidays, make sure you observe the precautions below:

1. Always turn off the main switch after consulting hours. (This is to stop supply of air, water, and electric power.) Make it a habit to do this to prevent water leak and electrical accidents.
2. After consulting hours, turn the water main valve knob counterclockwise to the vertical position to close the water main valve. Make it a habit to do this to prevent accidents by water leaks.
3. Turn off the breaker for the compressor, and discharge air. (Also make sure you have turned off the power.)
4. Turn off the breaker for the vacuum pump. (Also make sure you have turned off the power.)
5. Turn off the breaker for the device in the clinic. (Also make sure you have turned off the power.)
6. Set the chair to the lowest position and the backrest to the most reclined position.

### 8-1 After-sales service

When you request for repair

Refer to 'Troubleshooting' [from Page 217 on] before you check the device. If the problem persists, turn off the main switch, and contact your local authorized Belmont dealer to request a repair.

### 8-2 Service life

The service life of this product is 10 years on condition that maintenance and inspection are properly conducted [according to our self-certification (our data)].

However, the standard service lives of service parts that require periodic inspection vary according to the part. [Page 214]

### 8-3 Period of Parts Retention

We hold service parts such as consumables for products for 10 years from the time of launch.

\* Service parts are parts required for repair to return the product to the original state and functions or to maintain its functions.



## 9 Troubleshooting

### 9-1 Troubleshooting

If you encounter any of the problems listed below, take the countermeasures described below before requesting a repair. If the problem persists even after troubleshooting, stop using the product immediately, turn off the main switch, and contact your local authorized Belmont dealer.

Phenomenon	Please check	Remedy
The product does not work at all.	Is the main switch turned on?	Turn on the main switch. [Page 61]
	Is the power to the compressor turned on?	Turn on the power.
	Is the breaker for the device on the switch-board of the dentist's office turned on?	Turn on the breaker for the device.
The chair does not move.	Is the chair lock function activated?	Unlock the chair. [Pages 103 to 106]
	Have you been operating the product continuously for a long time?	The overheating prevention device for the hydraulic motor has been triggered. Wait for approx. 10 minutes, and move the chair.
The product cannot be operated with the wireless foot controller.	Are the correct batteries inserted?	Insert the batteries with proper polarities. [Page 131]
	Are the batteries flat?	Replace the batteries with new (or charged) ones with proper polarities. [Page 131]
	Is the wireless foot controller too far away from the product?	Keep the distance between the foot controller and product to approx. 1 meter or less.
	If you are using more than one products, are you mixing it up with another product's foot controller?	Check the pairing identification code, and use the combination with the same codes. [Page 130]
No air is being supplied.	Is the power to the compressor turned on?	Turn on the power.
	Is the knob that controls the air supply to the syringe or other parts closed?	Open the air supply control knob. [Pages 187, 188]
No water is being supplied.	Is the water main valve closed?	Open the water main valve. [Page 60]
	Is the water supply control knob to the handpiece or syringe closed?	Open the water supply control knob. [Pages 187, 188]
The vacuum handpiece or saliva ejector handpiece does not activate the suction function.	Is the power to the vacuum pump turned on?	Turn on the power.
	Is the solid collector filter dirty?	Clean the filter. [Page 208]
	Is the solid collector filter properly attached?	Attach the solid collector properly. [Page 208]
Is there a message displayed on the touch panel?	Read the message.	Take the corrective measures indicated in the message. [Pages 218 to 220]
Water keeps running from the cupfiller and doesn't stop.	Is there any dirt or droplet on the surface of cupfiller sensor?	Turn off the main switch and clean the surface of the cupfiller sensor.
Water doesn't come out of the cupfiller.	Is there any dirt or droplet on the surface of cupfiller sensor?	Turn off the main switch and clean the surface of the cupfiller sensor.
	Isn't the sensor disable mode activated?	Cancel the sensor disable mode. [Page 136]

## 9-2 Message on the touch panel and measures to be taken

Message on the touch panel	Details	Remedy
E01: Communication w/cuspidor section	Internal communication error for the device	Turn off the main switch, and contact your local authorized Belmont dealer.
E02: Communication w/FC		
E03: Communication w/water heater (HP)		
E04: Communication w/micromotor		
E05: Communication w/scalar		
E06: Communication w/chair		
E07: Communication w/cupfiller		
E08: Communication w/Washing the vacuum line		
E12: Control panel (Dr.)	The membrane switch is pressed when the power is turned on.	Keep your hand away from the membrane switch. If the error code does not go off when your hand is removed, contact your local authorized Belmont dealer.
E13: Control panel (ASST)	The switch on the assistant's control panel is pressed when the power is turned on.	Keep your hand away from the assistant's control panel. If the error code does not go off when your hand is removed, contact your local authorized Belmont dealer.
E14: Air pressure too low	The master pressure in the pneumatic system decreases.	Turn off the main switch, and contact your local authorized Belmont dealer.
E20: HP picked up while FC is on	The pedal of the foot controller is stepped on when the handpiece is picked up.	Release the pedal of the foot controller. If the error code does not go off when you take your foot off, contact your local authorized Belmont dealer.
E22: Foot controller (Slide)	A wire in the foot controller has become disconnected.	Turn off the main switch, and contact your local authorized Belmont dealer.
E24: Communication line with FC is busy.	Communications from the foot controller are jammed. (Wireless foot controller)	Use the cable contained in the package.
E25: Foot controller EEPROM	EEPROM (memory contents) read error for the foot controller	Turn off the main switch, and contact your local authorized Belmont dealer.
E30: Chair EEPROM	EEPROM (memory contents) read error for the chair	
E31: Potentiometer (Seat)	Chair position detection error	
E32: Potentiometer (Backrest)		
E33: Potentiometer (Legrest)		
E34: Thermistor (Solenoid valve)		

## 9 Troubleshooting

Message on the touch panel	Details	Remedy
E35: Stick switch	The stick switch is pressed when the power is turned on.	Check that there is not a leg or an object in contact with the stick switch on the chair. If nothing is in contact with it but the error code does not go off, contact your local authorized Belmont dealer.
E37: Potentiometer (Roll-up legrest)	Chair position detection error	Turn off the main switch, and contact your local authorized Belmont dealer.
E38: Potentiometer (Headrest)		
E39: Timeout (Chair)		
E42: Timeout (Cupfiller)	Cup-filling was not completed within the specified time.	If the water supply is insufficient, adjust the supply with the cupfiller control knob. If the error code does not go off after adjustment, contact your local authorized Belmont dealer.
E43: Cupfiller EEPROM	EEPROM (memory contents) read error in cupfiller	Turn off the main switch, and contact your local authorized Belmont dealer.
E44: No water in the bottle	The water level detection inside the bottle or the solenoid valve is behaving abnormally.	Press the <input type="button" value="OK"/> switch. Return the vacuum and saliva ejector handpieces to the instrument holder, and then contact your local authorized Belmont dealer.
E45: Water in the bottle cannot be discharged.	The vacuum and saliva ejector handpiece are not connected to the insertion point.	Press the <input type="button" value="OK"/> switch and try again.
	The water level detection inside the bottle or the water suctioning function is behaving abnormally.	Press the <input type="button" value="OK"/> switch. Return the vacuum and saliva ejector handpieces to the instrument holder, and then contact your local authorized Belmont dealer.
E46: Cleaner pump is not functioning.	The pump is overloaded.	

## 9 Troubleshooting

Message on the touch panel	Details	Remedy
C01: Cancelled. Dr table is in the way.	The doctor table has been moved behind the backrest while the chair is moving, and the chair stops in the middle.	Move the doctor table next to the armrest, and move the chair.
C02: Cancelled. Dr table is in contact.	An object is interfering with the doctor table while the chair is moving, and the chair stops in the middle.	Remove the cause of the emergency stop, and move the chair. When the chair moves properly, the error code will go off.
C03: Cancelled. Asst arm is in contact.	An object is interfering with the assistant arm while the chair is moving, and the chair stops in the middle.	
C04: Cancelled. Cuspidor bowl is in the way.	The cuspidor bowl is removed while the chair is moving, and the chair stops in the middle.	
C05: Cancelled. Footrest is in contact.	An object is interfering with the footrest while the chair is moving, and the chair stops in the middle.	Remove the cause of the emergency stop, and move the chair. When the chair moves properly, the error code will go off.
C06: Cancelled. Backrest is in contact.	An object is interfering with the backrest while the chair is moving, and the chair stops in the middle.	
C07: Cancelled. Rear link cover is in contact.	An object is interfering with the rear link cover while the chair is moving, and the chair stops in the middle.	
C08: Cancelled. Utility box is in contact.	An object is interfering with the top surface of the junction box and the junction box lid has come off while the chair is moving, and the chair stops in the middle.	Remove the cause of the emergency stop, fix the lid of the junction box back in place, and move the chair.
C09: Cancelled. FC is in contact.	The pedal is stepped on while the chair is moving, and the chair stops in the middle.	Release the pedal of the foot controller, and move the chair. When the chair moves properly, the error code will go off.
C10: Wait. Chair is warming up.	When the temperature is low, the chair warming-up function is activated.	Wait until the error code goes off (or warming up is completed)
C12: First priority (Handpiece)	The priority function is activated.	Return all the handpieces to the instrument holder. If the error code does not go off, contact your local authorized Belmont dealer.
C13: Return handpiece to holder.	A handpiece is not placed in the instrument holder when the power is turned on.	Check that all the handpieces are placed in the instrument holder. If the error code does not go off with all the handpieces in place, contact your local authorized Belmont dealer.
C14: LP position	When the chair is to be moved from the last position to the gargle position, the chair is already at the gargle position	Move the chair using a switch other than the last position switch.

### 10-1 Accessories

Instructions for Use (this document)  
Installation Instructions  
Declaration of Conformity  
Cable (only for the wireless foot controller)

### 10-2 Consumables

Consumables are parts that will normally wear or deteriorate, change their appearance, or become damaged after use. Please note that repair or replacement of consumables are not covered by the warranty and will be charged for.

(\* Degree of wear, deterioration or damage and timing for replacement depends on the use environment and conditions at the customer's premises.)

Consumables (Parts listed below are out of the guarantee coverage and charged parts.)

[Reference] List of service parts required for the periodic inspection  
[Page 214]



TAKARA COMPANY EUROPE GmbH

Berner Strasse 18, 60437  
Frankfurt am Main, Germany  
TEL : +49-69-506878-0  
FAX : +49-69-506878-20



 **Belmont**

TAKARA BELMONT CORPORATION

2-1-1, Higashishinsaibashi, Chuo-ku, Osaka, 542-0083, Japan

TEL : +81-6-6213-5945

FAX : +81-6-6212-3680

